

QUICK INSTALL GUIDE AND USER MANUAL

KVXLCH-100, KVXLCHF-100, KVXLCH-200, KVXLCHF-200, KVXLCHDP-200, KVXLCHDPF-200

KVX SERIES 4K HDMI KVM EXTENDER

24/7 TECHNICAL SUPPORT AT 1.877.877.2269 OR VISIT BLACKBOX.COM



BLACK BOX

TABLE OF CONTENTS

QUICK INSTALLATION GUIDE	3
1. SPECIFICATIONS	4
2. OVERVIEW	6
2.1 Introduction.....	6
2.2 Features.....	6
2.3 What's Included.....	6
2.4 Hardware Description.....	7
2.4.1 Transmitter.....	7
2.4.2 Receiver.....	11
3. CONNECTION DIAGRAM	15
4. INSTALLATION	16
APPENDIX A. REGULATORY INFORMATION	17
A.1 FCC Statement.....	17
A.2 NOM Statement.....	18
APPENDIX B. DISCLAIMER/TRADEMARKS	19
B.1 Disclaimer.....	19
B.2 Trademarks.....	19



QUICK INSTALLATION GUIDE

Follow these steps to install the extender:

1. If you have the fiber models, install the SFPs in the transmitter and receiver. Compatible SFPs from Black Box are listed in the table below.

COMPATIBLE SFP MODULES		
PART NUMBER	DESCRIPTION	DISTANCE
1-GBPS CONNECTIONS		
LFP441	SFP 1.25-Gb, 850-nm Multimode Fiber, LC	550 m
LFP442	SFP 1.25-Gb, 1310-nm Single-mode Fiber, LC	20 km
LFP412	SFP with Extended Diagnostics - 1250-Mbps Multimode Fiber, 1310-nm	2 km
LFP413	SFP with Extended Diagnostics - 1250-Mbps Single-Mode Fiber, 1310-nm	10 km
LFP414	SFP with Extended Diagnostics - 1250-Mbps, Singlemode Fiber, 1310-nm	30 km
LFP416	SFP 1250-Mbps, Extended Diagnostics, 10/100/1000BASE-T, SGMII Interface, RJ-45	100 m

NOTE: Other SFPs may work but have not been validated by Black Box, we recommend you use the suggested SFPs to avoid technical incompatibilities. SFP is not included in the package, must be ordered separately.

2. Connect one end of an HDMI cable to the HDMI port on the source device (e.g. computer, server or other IT device). Then connect the other end to the HDMI IN port located on the TX unit.
3. Connect the HDMI display to the HDMI OUT port on the TX unit.
4. Connect the HDMI display to the HDMI OUT port on the RX unit.
5. Connect the USB ports of the source device and the TX unit with a USB type A-B cable. Then plug a USB keyboard, mouse, or other USB devices into the USB ports of the RX unit.
6. Connect the RS-232 ports of the source device and the TX unit. Then connect the RS-232 ports of the RS-232 device on the RX unit side and the RX unit.
7. Connect the microphone/speaker ports of the source device and the TX unit with the audio microphone/speaker combo cable of the accessory. Then, plug the microphone and speaker into the microphone and speaker ports of the RX unit.
8. For the CATx model, use a CAT5e cable to connect the CATx link ports on the TX unit and the RX unit.
9. For the fiber model, use two SFP modules and an optical fiber cable to connect the fiber link ports on the TX unit and the RX unit.
10. Plug the power adapter cable into the DC jacks on the TX and RX units.

NOTES:

- a. We recommend using the highest quality materials (cables, SFP, etc.) to ensure optimal transmission quality.
- b. If the screen does not display when you connect the computer:
 1. Make sure the device cables are correctly and firmly attached.
 2. Set your display device's (TV, monitor, etc.) input source as HDMI.
 3. Check the PC BIOS configuration of the video output setting.
 4. Connect your video source to the Display DIRECTLY to check if the video signal gets through.

NOTES:

1. Both the HDMI displays respectively connecting to TX and RX units MUST support the same maximum video resolution.
2. SFP module's bandwidth requirement is 1 Gbps minimum.
3. When plugging into any microphone or speaker ports of TX or RX units, digital HDMI audio extension will be disabled and only analog audio LINE-IN/LINE-OUT extension is enabled.

CHAPTER 1: SPECIFICATIONS**TABLE 1-1. TRANSMITTER SPECIFICATIONS**

Console Connection	
Video Output	N/A
Serial Control Port	(1) DB9 female
Host Connection	
Video Input	KVXLCH-100, KVXLCHF-100: (1) HDMI female; KVXLCH-200, KVXLCHF-200: (2) HDMI female; KVXLCHDP-200, KVXLCHDPF-200: (1) HDMI female, (1) DisplayPort female
Local Out Video Connection	
Local Out	KVXLCH-100, KVXLCHF-100: (1) HDMI female; KVXLCH-200, KVXLCHF-200: (2) HDMI female; KVXLCHDP-200, KVXLCHDPF-200: (1) HDMI female, (1) DisplayPort female
Link Port	
RJ-45 (KVXLCH-100, KVXLCH-200, KVXLCHDP-200 transmitter)	CATx cable – max. length: 330 feet (100 meters)
SFP (KVXLCHF-100, KVXLCHF-200, KVXLCHDPF-200 transmitter)	Fiberoptic cable – max. length: 18.6 miles (30 km), depending on SFP NOTE: SFP is not included. Must be ordered separately.
USB Interface	
Host	(1) USB Type B female
Device	N/A
Audio	
2-way analog audio	(1) Line In, (1) Line Out
Serial	
RS-232 Extension Port	(1) DB9 female (Fixed at 115,200 baud, not changeable)
General	
LED indicator	Power: White LED
DDC Supported	DDC, DDC2, DDC2B
Max. Video Resolution	4K @ 30 Hz, 3840 x 2160 @ 30 Hz
OS Compatibility	OS Independent
Housing material	Chassis Metal
Operating Temperature	32 to 122° F (0 to 50° C)
Storage Temperature	-4 to +140° F (-20 to +60° C)
Relative Humidity	0 to 80%
Power Supply	External 5-VDC, 2-A power supply
Dimensions	KVXLCH-100, KVXLCHF-100: 0.83" H x 7.09" W x 3.27" D (2.1 x 18 x 8.3 cm); KVXLCH-200, KVXLCHF-200: 1.71" H x 7.09" W x 3.27" D (4.4 x 18 x 8.3 cm) KVXLCHDP-200, KVXLCHDPF-200: 1.71" H x 7.09" W x 3.27" D (4.4 x 18 x 8.3 cm)
Weight	KVXLCH-100 transmitter: 0.82 lb. (0.372 kg) KVXLCHF-100 transmitter: 0.83 lb. (0.378 kg) (no SFP); KVXLCH-200 transmitter: 0.82 lb. (0.372 kg); KVXLCHF-200 transmitter: 0.82 lb. (0.372 kg) (no SFP); KVXLCHDP-200 transmitter: 0.84 lb. (0.381 kg); KVXLCHDPF-200 transmitter: 0.84 lb. (0.381 kg) (no SFP)



CHAPTER 1: SPECIFICATIONS

TABLE 1-2. RECEIVER SPECIFICATIONS

Console Connection	
Video Output	KVXLCH-100, KVXLCHF-100: (1) HDMI female; KVXLCH-200, KVXLCHF-200, KVXLCHDP-200, KVXLCHDPF-200: (2) HDMI female
Serial Control Port	(1) DB9 male
Host Connection	
Video Input	N/A
Link Port	
RJ-45 (KVXLCH-100, KVXLCHDP-200 receiver)	CATx cable – max. length: 330 feet (100 meters)
SFP (KVXLCHF-100, KVXLCHDPF-200 receiver)	Fiber optic cable – max. length: 18.6 miles (30 km), depending on SFP NOTE: SFP is not included. Must be ordered separately.
USB Interface	
Host	N/A
Device	(4) USB 2.0 Type A female
Audio	
2-way analog audio	(1) MIC In, (1) Speaker Out
Serial	
RS-232 Extension Port	(1) DB9 male (Fixed at 115,200 baud, not changeable)
General	
LED indicator	Power: White LED
DDC Supported	DDC, DDC2, DDC2B
Max. Video Resolution	4K @ 30 Hz, 3840 x 2160 @ 30 Hz
OS Compatibility	OS Independent
Housing material	Chassis Metal
Operating Temperature	32 to 122° F (0 to 50° C)
Storage Temperature	-4 to +140° F (-20 to +60° C)
Relative Humidity	0 to 80%
Power Supply	External 5-VDC, 2-A power supply
Dimensions	KVXLCH-100, KVXLCHF-100: 0.83" H x 7.09" W x 3.27" D (2.1 x 18 x 8.3 cm); KVXLCH-200, KVXLCHF-200, KVXLCHDP-200, KVXLCHDPF-200: 1.71" H x 7.09" W x 3.27" D (4.4 x 18 x 8.3 cm)
Weight	KVXLCH-100 receiver: 0.82 lb. (0.372 kg) KVXLCHF-100 receiver: 0.83 lb. (0.378 kg) (no SFP); KVXLCH-200 receiver: 0.83 lb. (0.378 kg) KVXLCHF-200 receiver: 0.83 lb. (0.378 kg) (no SFP); KVXLCHDP-200 receiver: 0.85 lb. (0.386 kg); KVXLCHDPF-200 receiver: 0.84 lb. (0.381 kg) (no SFP)

CHAPTER 2: OVERVIEW

2.1 INTRODUCTION

The K VX Series 4K HDMI KVM Extenders (single-head) enable you to locally use a 4K HDMI monitor, USB keyboard/mouse/other devices, speaker, and microphone to operate a remote computer, server or other IT device featuring a 4K HDMI video output. You can also view the 4K HDMI video output of the remote source devices via the HDMI output port on 4K HDMI KVM Extender's TX unit. Dual-head models support (1) HDMI and (1) DisplayPort inputs on the transmitters to accommodate video cards with multiple outputs, and (2) HDMI outputs on the receivers.

There are six models of the K VX Series 4K HDMI KVM Extender: the single-head models are K VX LCH-100 via a CATx link and K VX LCHF-100 via a fiberoptic link. The dual-head models are K VX LCH-200 and K VX LCHDP-200 via a CATx link and K VX LCHF-200 and K VX LCHDPF-200 via a fiberoptic link. Each extender consists of a transmitter (TX) and a receiver (RX).

2.2 FEATURES

- ◆ Single-head models support HDMI input/output video quality up to 4K @ 30 Hz, 3840 x 2160 @ 30 Hz.
- ◆ Dual-head models support HDMI or DisplayPort input/HDMI output video quality up to 4K @ 30 Hz, 3840 x 2160 @ 30 Hz.
- ◆ Has 4K HDMI local video loopback on the single-head TX units and 4K HDMI/DisplayPort local video loopback on the dual-head TX units
- ◆ Provides remote access for video/USB/RS-232/audio extension distance up to 330 feet (100 meters) over CATx cable for model K VX LCH-100 or K VX LCH-200 and K VX LCHDP-200; up to 18.6 miles (30 km) over fiberoptic cable for model K VX LCHF-100 or K VX LCHF-200 and K VX LCHDPF-200, depending on the SFP used.
- ◆ The HDMI KVM Console Extender lets you control a server, or computer over single-mode or multimode fiber optic cable at distances of up to 30 km (depending on the SFP used, fiber type, and fiber bandwidth*).
- ◆ Offers transparent USB 2.0/1.1 extension.
- ◆ Uses analog audio LINE-IN/LINE-OUT extension.
- ◆ Supports bi-directional RS-232 control communication at a fixed baud rate of 115200.
- ◆ Automatic EDID update.

*NOTE: Reference the supported SFP chart on page 3.

2.3 WHAT'S INCLUDED

K VX LCH-100:

- ◆ (1) Transmitter (TX)
- ◆ (1) Receiver (RX)
- ◆ (2) 5V, 2A Power Supplies (includes US, EU, and UK plug types)
- ◆ (1) HDMI cable 1.2m (4 ft.)
- ◆ (1) 3.5mm audio cable 1.8m (6 ft.)
- ◆ (1) USB-B to USB-A Cable 1.8m (6 ft.)
- ◆ (2) Deskmount Kits with Screws (K VX LC-DMK)

K VX LCHF-100:

- ◆ (1) Transmitter (TX)
- ◆ (1) Receiver (RX)
- ◆ (2) 5V, 2A Power Supplies (includes US, EU, and UK plug types)
- ◆ (1) HDMI cable, M/M 1.2m (4 ft.)
- ◆ (1) USB Type A to B cable, M/M 1.8m (6 ft.)
- ◆ (1) 3.5mm Dual Audio/Mic Cable, M/M 1.8m (6 ft.)
- ◆ (2) Deskmount Kits with Screws (K VX LC-DMK)

K VX LCH-200:

- ◆ (1) Transmitter (TX)
- ◆ (1) Receiver (RX)
- ◆ (2) 5V, 2A Power Supplies (includes US, EU, and UK plug types)
- ◆ (2) HDMI cables 1.2m (4ft.)
- ◆ (1) 3.5mm cable 1.8m (6 ft.)
- ◆ (1) USB-B to USB-A cable 1.8m (6 ft.)
- ◆ (2) Deskmount Kits with Screws (K VX LC-DMK)

K VX LCHF-200:

- ◆ (1) Transmitter (TX)
- ◆ (1) Receiver (RX)
- ◆ (2) 5V, 2A Power Supplies (includes US, EU, and UK plug types)
- ◆ (2) HDMI cables 1.2m (4 ft.)
- ◆ (1) 3.5mm audio cable 1.8m (6 ft.)
- ◆ (1) USB-B to USB-A cable 1.8m (6-ft.)
- ◆ (2) Deskmount Kits with Screws (K VX LC-DMK)



CHAPTER 2: OVERVIEW

KVXLCHDP-200

- (1) Transmitter (TX)
- (1) Receiver (RX)
- (2) 5V, 2A Power Supplies (includes US, EU, and UK plug types)
- (2) HDMI cables 1.2m (4 ft.)
- (2) DisplayPort Cables 1.2m (4 ft.)
- (1) 3.5mm audio/mic cable 1.8m (6 ft.)
- (1) USB-B to USB-A cable 1.8m (6 ft.)
- (2) Deskmount Kits with Screws (KVXLC-DMK)

KVXLCHDPF-200:

- (1) Transmitter (TX)
- (1) Receiver (RX)
- (2) 5V, 2A Power Supplies (includes US, EU, and UK plug types)
- (2) HDMI cables 1.2m (4 ft.)
- (2) DisplayPort Cables 1.2m (4 ft.)
- (1) 3.5mm audio cable 1.8m (6 ft.)
- (1) USB-B to USB-A cable 1.8m (6 ft.)
- (2) Deskmount Kits with Screws (KVXLC-DMK)

2.4 HARDWARE DESCRIPTION

2.4.1 TRANSMITTER

FRONT PANEL

Figure 2-1 shows the front panel that is common to the single-head CATx and fiber transmitters. Table 2-1 describes the components.

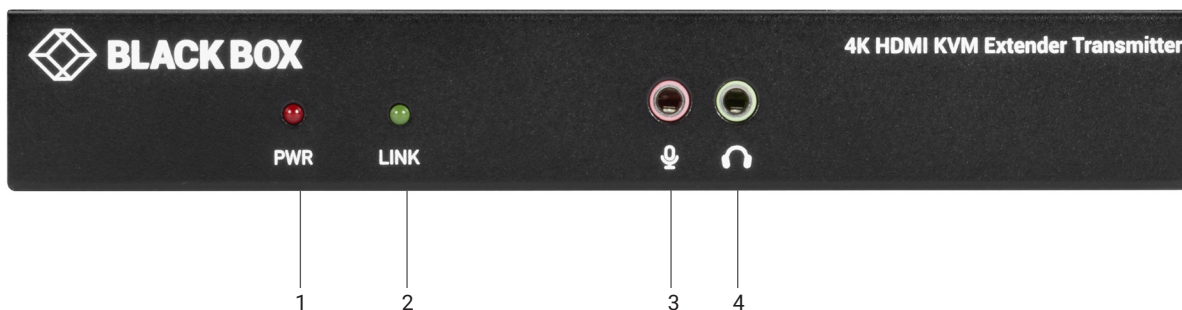

FIGURE 2-1. SINGLE-HEAD TRANSMITTER FRONT PANEL

Figure 2-2 shows the front panel that is common to the dual-head CATx and fiber transmitters. Table 2-1 describes the components.

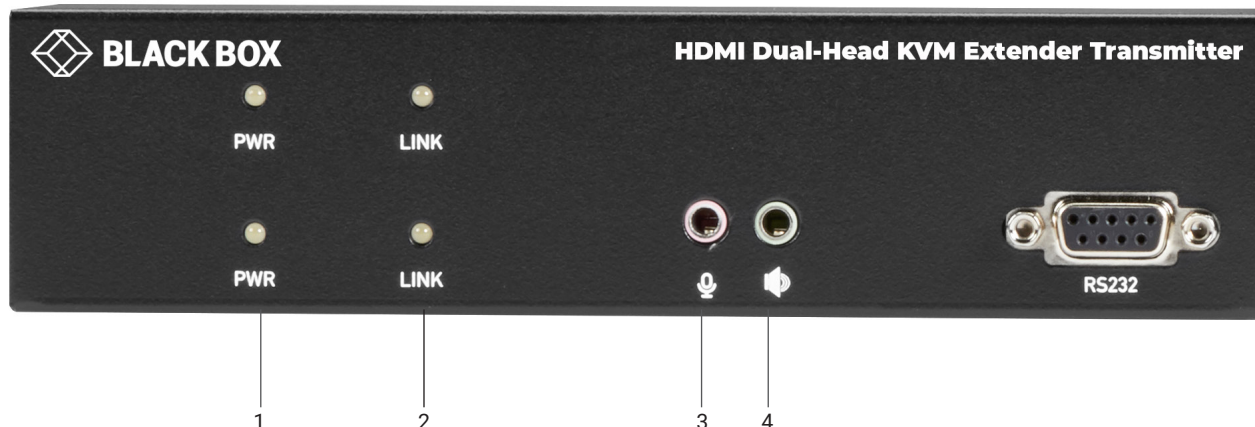

FIGURE 2-2. HDMI DUAL-HEAD TRANSMITTER FRONT PANEL

CHAPTER 2: OVERVIEW

Figure 2-3 shows the front panel that is common to the dual-head CATx and fiber transmitters. Table 2-1 describes the components.

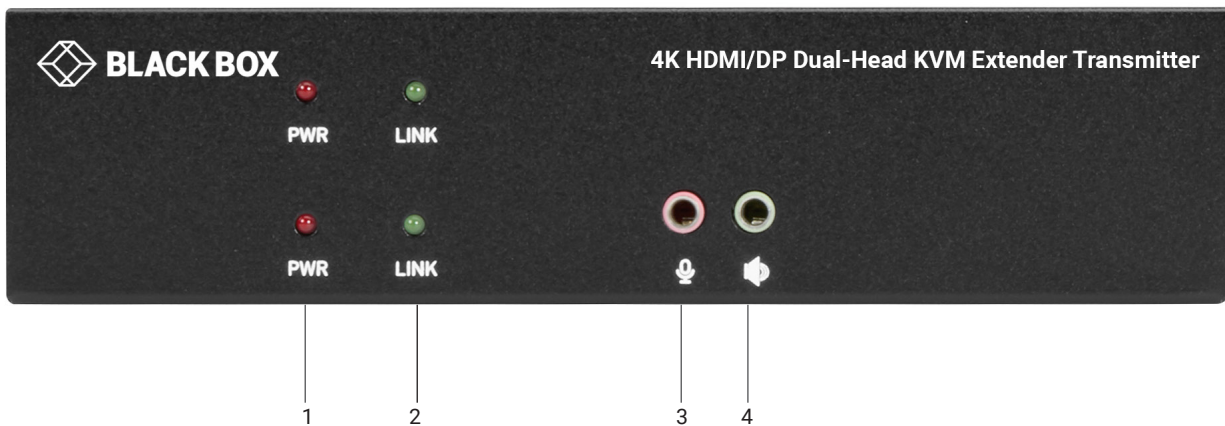

FIGURE 2-3. HDMI/DP DUAL-HEAD TRANSMITTER FRONT PANEL

TABLE 2-1. TRANSMITTER FRONT-PANEL COMPONENTS

NUMBER IN FIGURE 2-1 OR 2-2	COMPONENT	DESCRIPTION
1	PWR LED	Lights when power to the transmitter is ON
2	Link LED	Lights when the link between transmitter and receiver units is ON; OFF when the link between transmitter and receiver units is OFF
3	Audio jack	Connects to analog audio input for audio extension
4	Audio jack	Connects to analog audio output for audio extension

BACK PANEL

Figures 2-4 and 2-5 show the back panels of the single-head CATx and fiber transmitters. Table 2-2 describes their components.

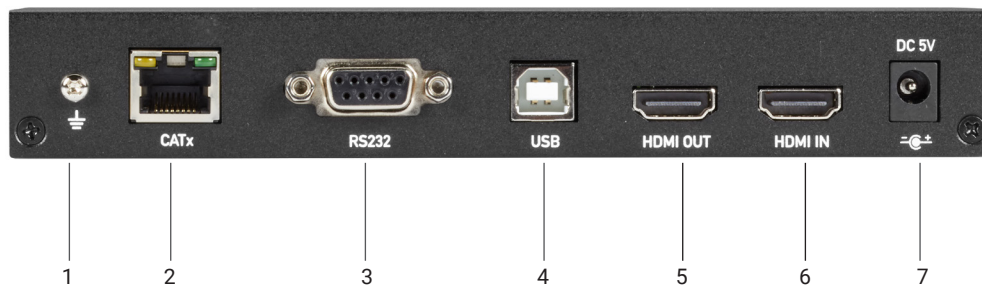

FIGURE 2-4. SINGLE-HEAD CATX TRANSMITTER BACK PANEL

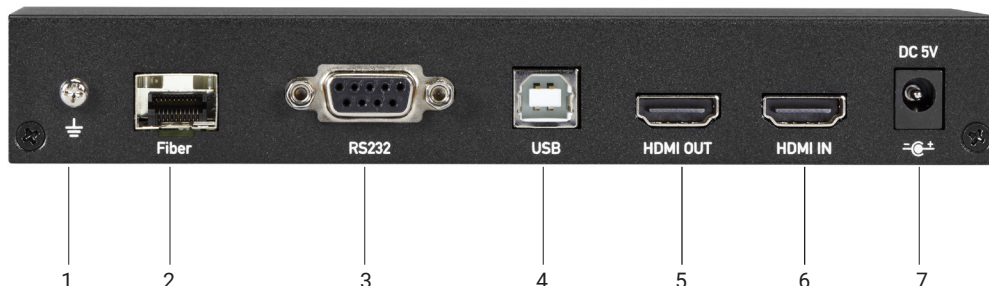

FIGURE 2-5. SINGLE-HEAD FIBER TRANSMITTER BACK PANEL

TABLE 2-2. SINGLE-HEAD TRANSMITTER BACK-PANEL COMPONENTS

NUMBER IN FIGURE 2-3 OR 2-4	COMPONENT	DESCRIPTION
1	Ground screw	Links to ground
2	For CATx model: RJ-45 connector; For Fiber model: SFP cage	For CATx Model: CATx link; For Fiber model: Install fiber SFP module here
3	DB9 connector	Connects to source device's RS-232 port for serial extension
4	USB Type B connector	Connects to source device's USB port
5	HDMI Out port	Connects to local out
6	HDMI In port	Connects to source device's signal for HDMI extension
7	Power connector	Links to 5-VDC power supply

Figures 2-6 and 2-7 show the back panels of the dual-head CATx and fiber transmitters. Table 2-3 describes their components.

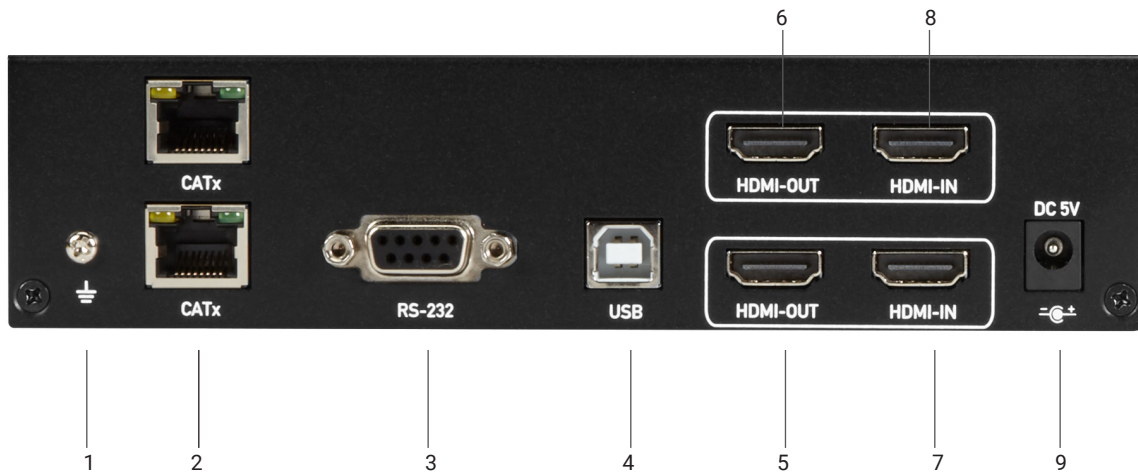

FIGURE 2-6. HDMI DUAL-HEAD CATX TRANSMITTER BACK PANEL

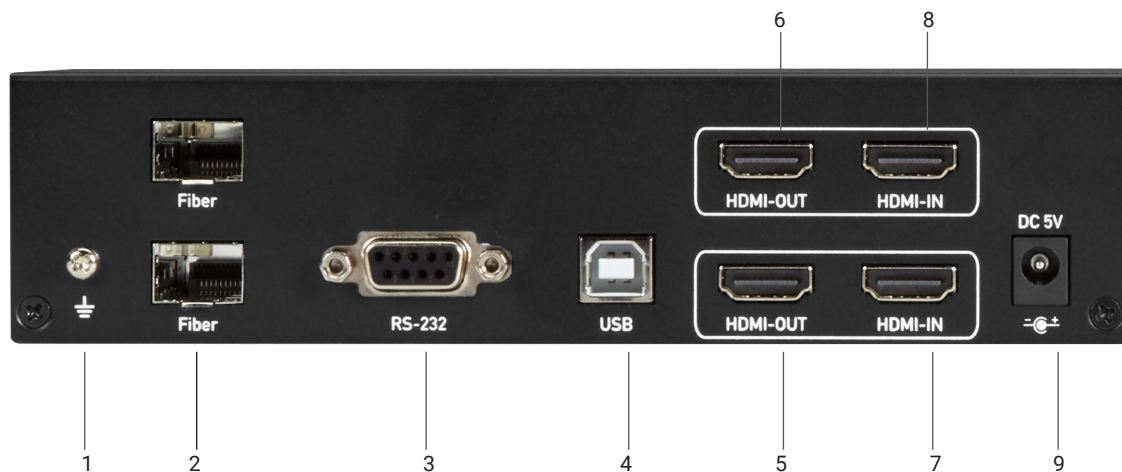

FIGURE 2-7. HDMI DUAL-HEAD FIBER TRANSMITTER BACK PANEL

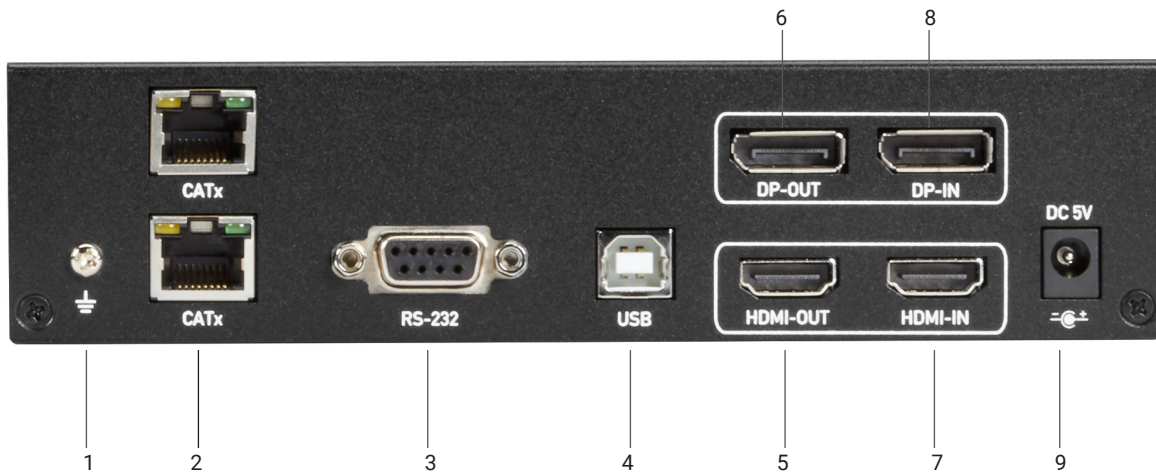

FIGURE 2-8. HDMI/DP DUAL-HEAD CATx TRANSMITTER BACK PANEL

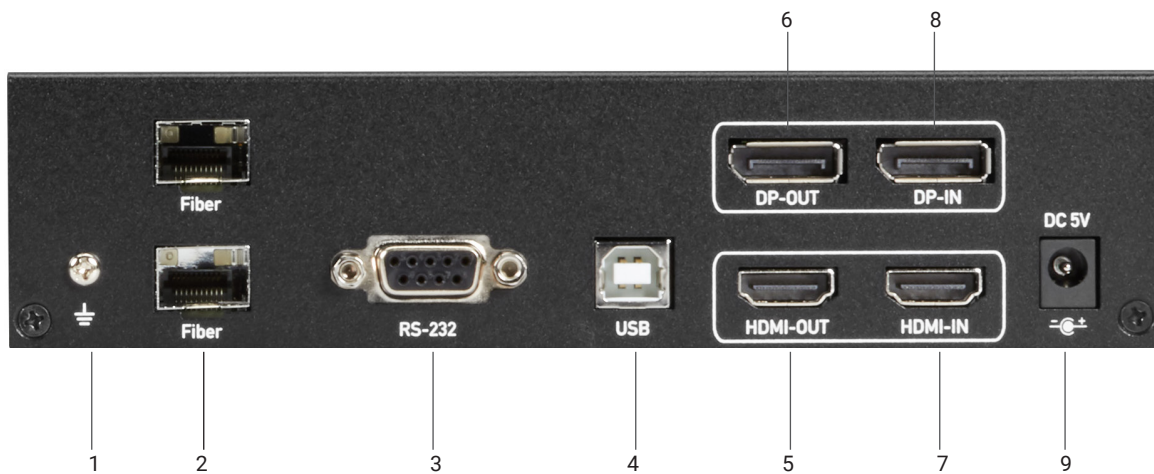

FIGURE 2-9. HDMI/DP DUAL-HEAD FIBER TRANSMITTER BACK PANEL

TABLE 2-3. DUAL-HEAD TRANSMITTER BACK-PANEL COMPONENTS

NUMBER IN FIGURE 2-5 OR 2-6	COMPONENT	DESCRIPTION
1	Ground screw	Links to ground
2	For CATx model: RJ-45 connector; For Fiber model: SFP cage	For CATx Model: CATx link; For Fiber model: Install fiber SFP module here
3	DB9 connector	Connects to source device's RS-232 port for serial extension
4	USB Type B connector	Connects to source device's USB port
5	(1) or (2) Local HDMI Out port(s)	Connects to local out
6	(0) or (1) Local DisplayPort Out port	Connects to local out
7	(1) or (2) HDMI Input port(s)	Connects to source device's signal for HDMI extension
8	(0) or (1) DisplayPort Input port	Connects to source device's signal for DisplayPort extension
9	Power connector	Links to 5-VDC power supply

2.4.2 RECEIVER

FRONT PANEL

Figure 2-10 shows the front panel that is common to the single-head CATx and fiber receivers. Table 2-4 describes its components.

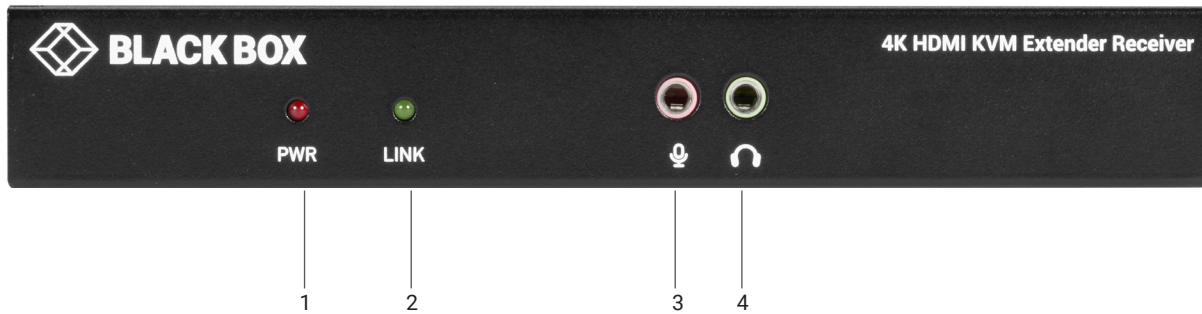

FIGURE 2-10 SINGLE-HEAD RECEIVER FRONT PANEL

Figure 2-11 shows the front panel that is common to the dual-head CATx and fiber receivers. Table 2-4 describes its components.

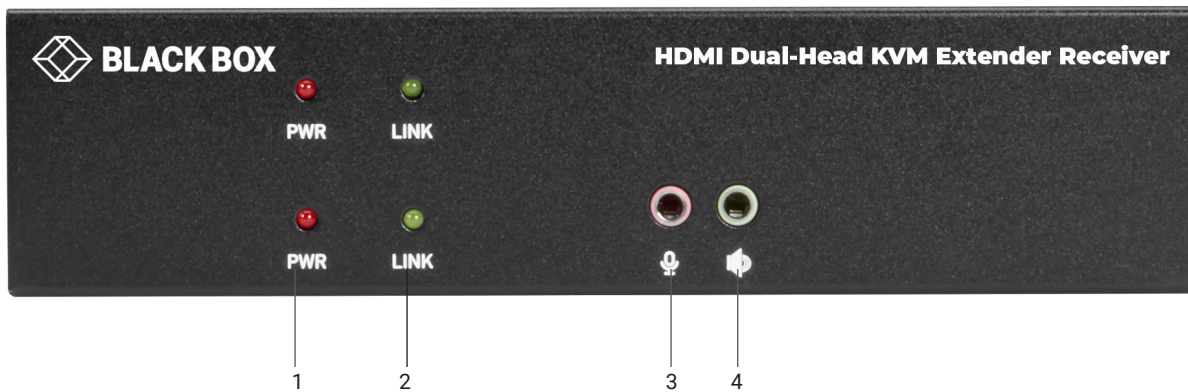

FIGURE 2-11. DUAL-HEAD RECEIVER FRONT PANEL

Figure 2-12 shows the front panel that is common to the dual-head CATx and fiber receivers. Table 2-4 describes its components.

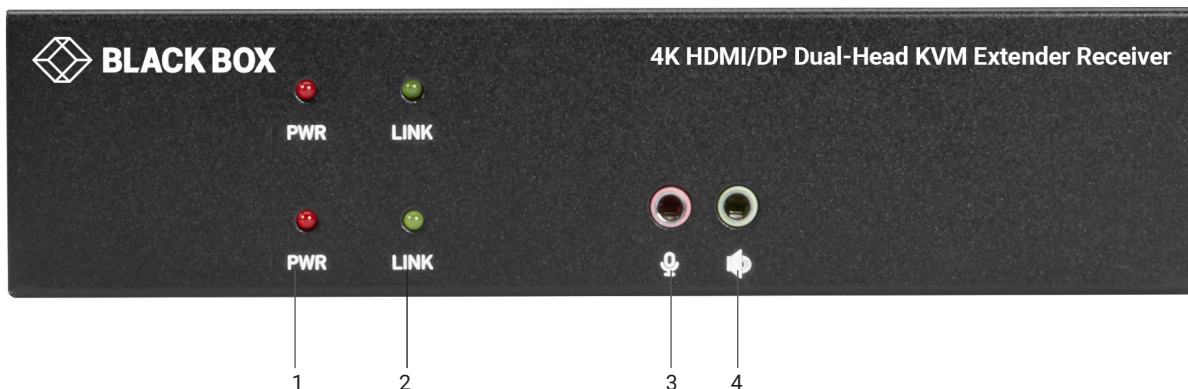

FIGURE 2-12. DUAL-HEAD RECEIVER FRONT PANEL

CHAPTER 2: OVERVIEW

TABLE 2-4. RECEIVER FRONT-PANEL COMPONENTS

NUMBER IN FIGURE 2-7 OR 2-8	COMPONENT	DESCRIPTION
1	PWR LED	Lights when power to the receiver is ON
2	Link LED	Lights when the link between transmitter and receiver units is ON; OFF when the link between transmitter and receiver units is OFF
3	Audio jack	Links to analog audio input for audio extension
4	Audio jack	Links to analog audio output for audio extension

BACK PANEL

Figures 2-13 and 2-14 show the back panels of the single-head CATx and fiber receivers. Table 2-5 describes their components.



FIGURE 2-13. SINGLE-HEAD CATX RECEIVER BACK PANEL

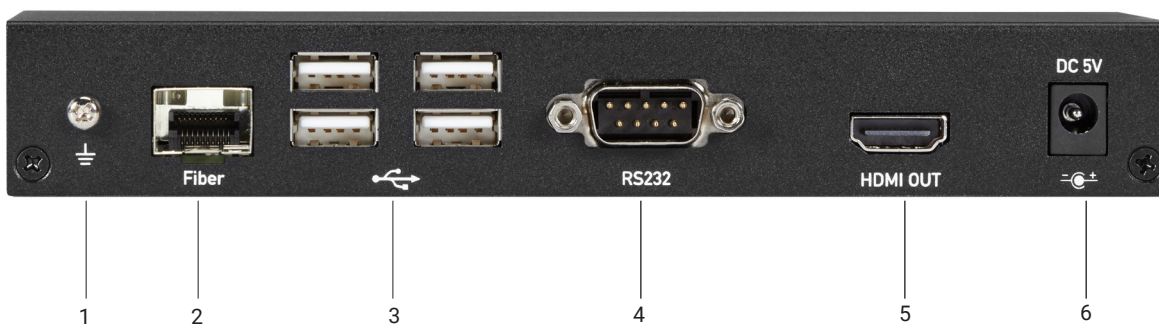

FIGURE 2-14. SINGLE-HEAD FIBER RECEIVER BACK PANEL

TABLE 2-5. SINGLE-HEAD RECEIVER BACK-PANEL COMPONENTS

NUMBER IN FIGURE 2-9 OR 2-10	COMPONENT	DESCRIPTION
1	Ground screw	Links to ground
2	For CATx model: RJ-45 connector For Fiber model: SFP cage	For CATx Model: CATx link For Fiber model: Install fiber SFP module here
3	(4) USB 2.0 ports	Connect to USB device ports for extension
4	DB9 connector	Connects to sink device's RS-232 port for serial extension
5	HDMI Out port	Connects to sink device's signal for HDMI video extension
6	Power connector	Links to 5-VDC power supply

Figures 2-15 and 2-16 show the back panels of the dual-head CATx and fiber receivers. Table 2-6 describes their components.

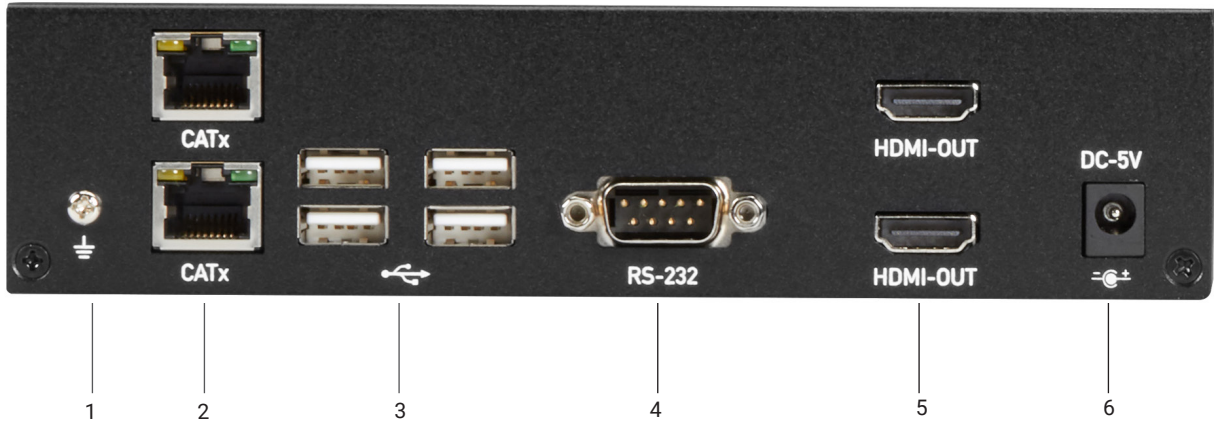

FIGURE 2-15. HDMI DUAL-HEAD CATX RECEIVER BACK PANEL

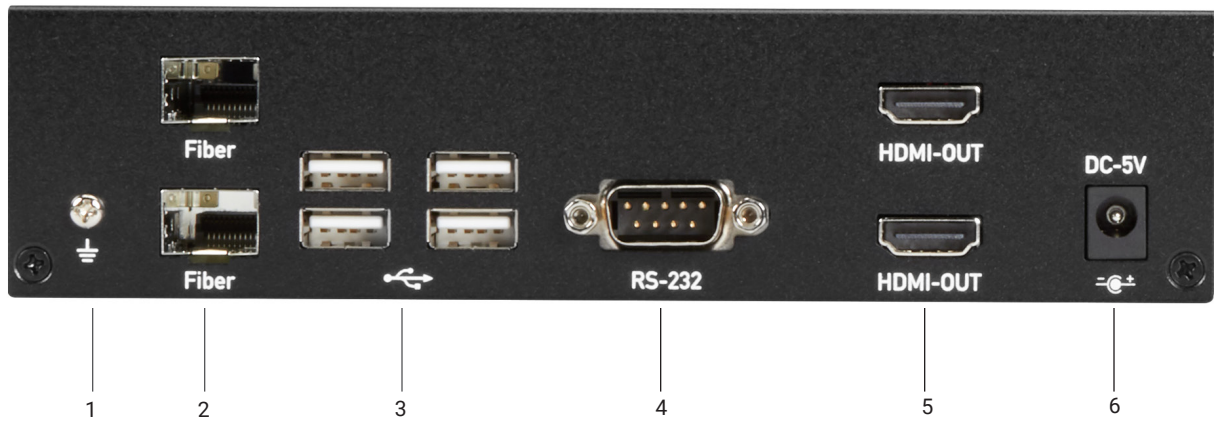

FIGURE 2-16. HDMI DUAL-HEAD FIBER RECEIVER BACK PANEL

Figures 2-17 and 2-18 show the back panels of the HDMI/DP dual-head CATx and fiber receivers. Table 2-6 describes their components.

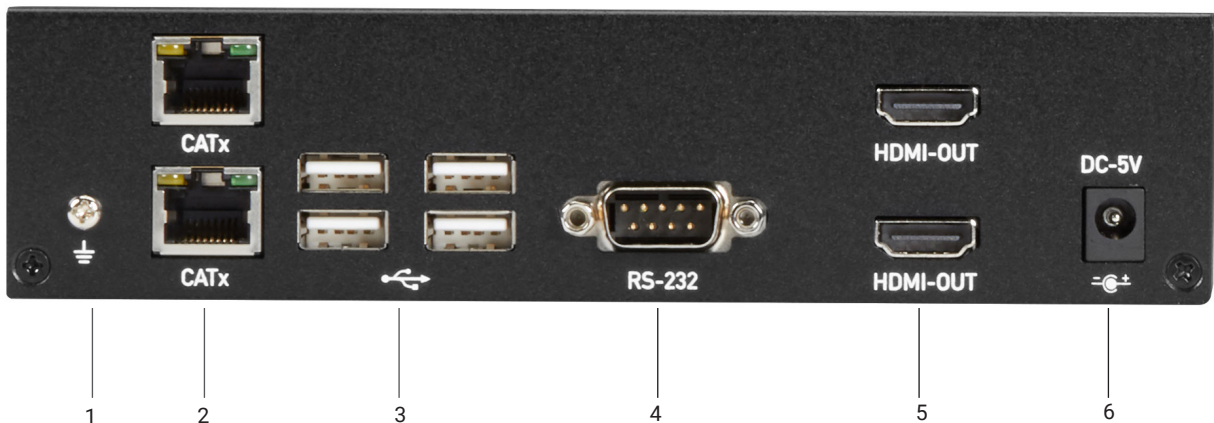

FIGURE 2-17. DUAL-HEAD CATX RECEIVER BACK PANEL

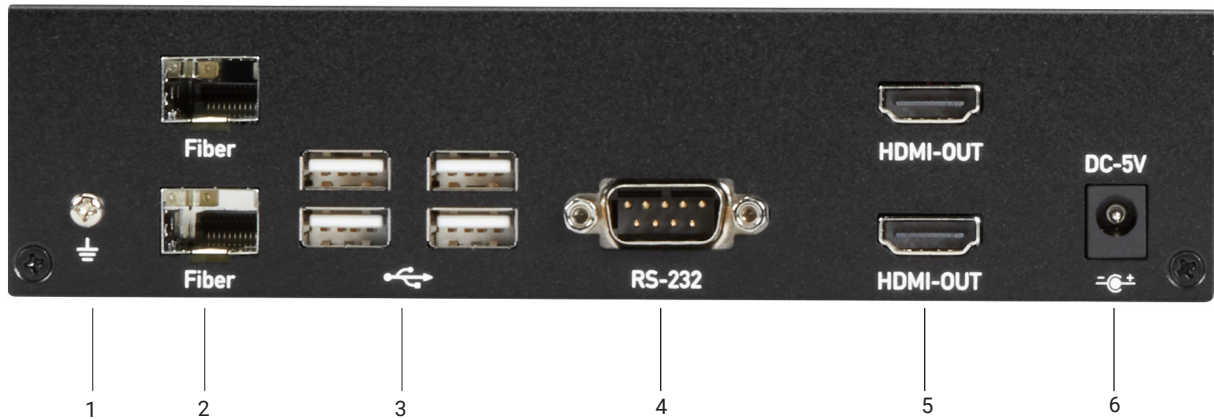

FIGURE 2-18. HDMI/DP DUAL-HEAD FIBER RECEIVER BACK PANEL

TABLE 2-6. DUAL-HEAD RECEIVER BACK-PANEL COMPONENTS

NUMBER IN FIGURE 2-11 OR 2-12	COMPONENT	DESCRIPTION
1	Ground screw	Links to ground
2	For CATx model: RJ-45 connector For Fiber model: SFP cage	For CATx Model: CATx link For Fiber model: Install fiber SFP module here
3	(4) USB 2.0 ports	Connect to USB device ports
4	DB9 connector	Connects to sink device's RS-232 port for serial extension
5	(2) HDMI Out ports	Connects to sink devices' signals for HDMI video extension
6	Power connector	Links to 5-VDC power supply

NOTE: While the HDMI/DP Transmitters have HDMI and DP ports, the HDMI/DP Receivers only have HDMI ports.

CHAPTER 3: CONNECTION DIAGRAM

Figures 3-1 and 3-2 show typical connections.

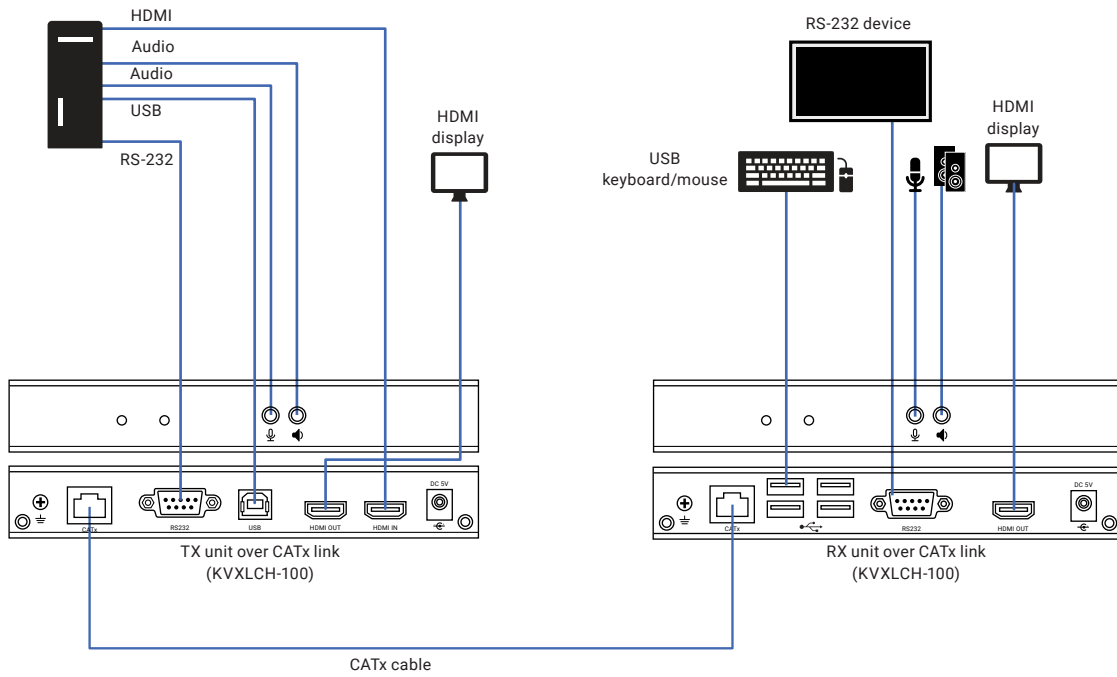

FIGURE 3-1. CATx MODEL CONNECTION DIAGRAM

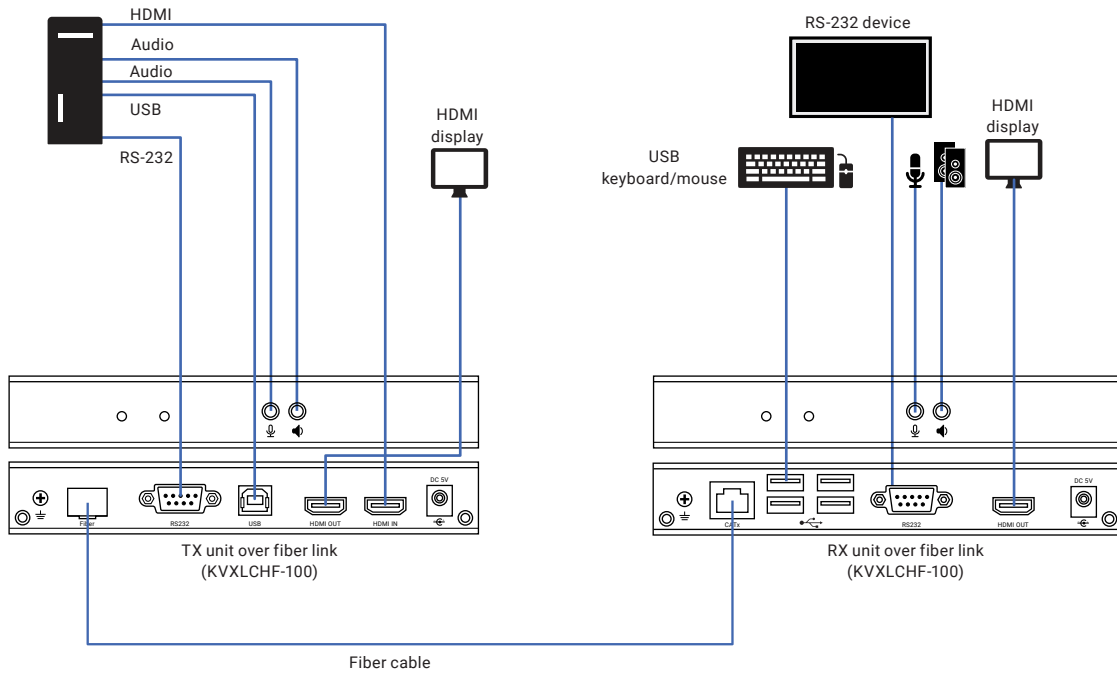

FIGURE 3-2. FIBER MODEL CONNECTION DIAGRAM

CHAPTER 4: INSTALLATION

Follow these steps to install the extender:

1. If you have the fiber models, install the SFPs in the transmitter and receiver. Compatible SFPs from Black Box are listed in the table on page 3 of this manual.

NOTE: Other SFPs may work but have not been validated by Black Box, we recommend you use the suggested SFPs to avoid technical incompatibilities.

NOTE: SFP is not included, must be ordered separately.

2. Connect one end of an HDMI cable to the HDMI port on the source device (e.g. computer, server or other IT device). Then connect the other end to the HDMI IN port located on the TX unit.
3. Connect the HDMI display to the HDMI OUT port on the TX unit.
4. Connect the HDMI display to the HDMI OUT port on the RX unit.
5. Connect the USB ports of the source device and the TX unit with a USB type A-B cable. Then plug a USB keyboard, mouse, or other USB devices into the USB ports of the RX unit.
6. Connect the RS-232 ports of the source device and the TX unit. Then connect the RS-232 ports of the RS-232 device on the RX unit side and the RX unit.
7. Connect the microphone/speaker ports of the source device and the TX unit with the audio microphone/speaker combo cable of the accessory. Then, plug the microphone and speaker into the microphone and speaker ports of the RX unit.
8. For the CATx model, use a CAT5e cable to connect the CATx link ports on the TX unit and the RX unit.
9. For the fiber model, use two SFP modules and an optical fiber cable to connect the fiber link ports on the TX unit and the RX unit.
10. Plug the power adapter cable into the DC jacks on the TX and RX units.

NOTES:

- a. We recommend using the highest quality materials (cables, SFP, etc.) to ensure optimal transmission quality.
- b. If the screen does not display when you connect the computer:
 1. Make sure the device cables are correctly and firmly attached.
 2. Set your display device's (TV, monitor, etc.) input source as HDMI.
 3. Check the PC BIOS configuration of the video output setting.
 4. Connect your video source to the Display DIRECTLY to check if the video signal gets through.

NOTES:

1. Both the HDMI displays respectively connecting to TX and RX units MUST support the same maximum video resolution.
2. SFP module's bandwidth requirement is 1 Gbps minimum.
3. When plugging into any microphone or speaker ports of TX or RX units, digital HDMI audio extension will be disabled and only analog audio LINE-IN/LINE-OUT extension is enabled.



APPENDIX A: REGULATORY INFORMATION

A.1 FCC CLASS A STATEMENT

This equipment generates, uses, and can radiate radio-frequency energy, and if not installed and used properly, that is, in strict accordance with the manufacturer's instructions, may cause interference to radio communication. It has been tested and found to comply with the limits for a Class A computing device in accordance with the specifications in Subpart B of Part 15 of FCC rules, which are designed to provide reasonable protection against such interference when the equipment is operated in a commercial environment. Operation of this equipment in a residential area is likely to cause interference, in which case the user at his own expense will be required to take whatever measures may be necessary to correct the interference.

Changes or modifications not expressly approved by the party responsible for compliance could void the user's authority to operate the equipment.

This digital apparatus does not exceed the Class A limits for radio noise emission from digital apparatus set out in the Radio Interference Regulation of Industry Canada.

Le présent appareil numérique n'émet pas de bruits radioélectriques dépassant les limites applicables aux appareils numériques de la classe A prescrites dans le Règlement sur le brouillage radioélectrique publié par Industrie Canada.

APPENDIX A: REGULATORY INFORMATION

A.2 NOM STATEMENT

1. Todas las instrucciones de seguridad y operación deberán ser leídas antes de que el aparato eléctrico sea operado.
2. Las instrucciones de seguridad y operación deberán ser guardadas para referencia futura.
3. Todas las advertencias en el aparato eléctrico y en sus instrucciones de operación deben ser respetadas.
4. Todas las instrucciones de operación y uso deben ser seguidas.
5. El aparato eléctrico no deberá ser usado cerca del agua—por ejemplo, cerca de la tina de baño, lavabo, sótano mojado o cerca de una alberca, etc.
6. El aparato eléctrico debe ser usado únicamente con carritos o pedestales que sean recomendados por el fabricante.
7. El aparato eléctrico debe ser montado a la pared o al techo sólo como sea recomendado por el fabricante.
8. Servicio—El usuario no debe intentar dar servicio al equipo eléctrico más allá a lo descrito en las instrucciones de operación. Todo otro servicio deberá ser referido a personal de servicio calificado.
9. El aparato eléctrico debe ser situado de tal manera que su posición no interfiera su uso. La colocación del aparato eléctrico sobre una cama, sofá, alfombra o superficie similar puede bloquea la ventilación, no se debe colocar en libreros o gabinetes que impidan el flujo de aire por los orificios de ventilación.
10. El equipo eléctrico deber ser situado fuera del alcance de fuentes de calor como radiadores, registros de calor, estufas u otros aparatos (incluyendo amplificadores) que producen calor.
11. El aparato eléctrico deberá ser conectado a una fuente de poder sólo del tipo descrito en el instructivo de operación, o como se indique en el aparato.
12. Precaución debe ser tomada de tal manera que la tierra física y la polarización del equipo no sea eliminada.
13. Los cables de la fuente de poder deben ser guiados de tal manera que no sean pisados ni pellizcados por objetos colocados sobre o contra ellos, poniendo particular atención a los contactos y receptáculos donde salen del aparato.
14. El equipo eléctrico debe ser limpiado únicamente de acuerdo a las recomendaciones del fabricante.
15. En caso de existir, una antena externa deberá ser localizada lejos de las líneas de energía.
16. El cable de corriente deberá ser desconectado del cuando el equipo no sea usado por un largo periodo de tiempo.
17. Cuidado debe ser tomado de tal manera que objetos líquidos no sean derramados sobre la cubierta u orificios de ventilación.
18. Servicio por personal calificado deberá ser provisto cuando:
 - A: El cable de poder o el contacto ha sido dañado; u
 - B: Objetos han caído o líquido ha sido derramado dentro del aparato; o
 - C: El aparato ha sido expuesto a la lluvia; o
 - D: El aparato parece no operar normalmente o muestra un cambio en su desempeño; o
 - E: El aparato ha sido tirado o su cubierta ha sido dañada.



APPENDIX B: DISCLAIMER/TRADEMARKS

B.1 DISCLAIMER

Black Box Corporation shall not be liable for damages of any kind, including, but not limited to, punitive, consequential or cost of cover damages, resulting from any errors in the product information or specifications set forth in this document and Black Box Corporation may revise this document at any time without notice.

B.2 TRADEMARKS USED IN THIS MANUAL

Black Box and the Black Box logo type and mark are registered trademarks of Black Box Corporation.

Any other trademarks mentioned in this manual are acknowledged to be the property of the trademark owners.

**NEED HELP?
LEAVE THE TECH TO US**

**LIVE 24/7
TECHNICAL
SUPPORT**

1.877.877.2269

BLACK BOX[®]

© COPYRIGHT 2021, 2022. BLACK BOX CORPORATION. ALL RIGHTS RESERVED.
KVXLCH-100_KVXLCHDP-200_QIG-USER_REV8.PDF