

# USER MANUAL

LPS500A-MM-LC-R3, LPS500A-MM-SC-R3, LPS500A-SM-10K-LC-R3

# 10/100/1000B-T TO 1000B-X POE PSE GBE MEDIA CONVERTER

24/7 TECHNICAL SUPPORT AT 1.877.877.2269 OR VISIT BLACKBOX.COM



**BLACK BOX**

10/100/1000BASE-T PoE PSE To 1000BASE-X  
Media Converter  
PoE-Power Sourcing Equipment

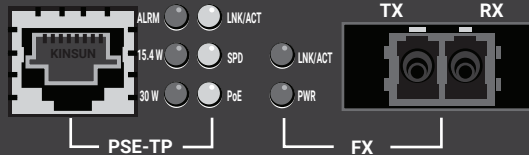

**BLACK BOX**

# TABLE OF CONTENTS

<b>CONTENTS</b>	
SAFETY INFORMATION .....	3
1. SPECIFICATIONS .....	4
2. OVERVIEW.....	5
2.1 INTRODUCTION.....	5
2.2 AVAILABLE MODELS.....	5
2.3 FEATURES.....	5
2.4 WHAT'S INCLUDED.....	5
2.5 HARDWARE DESCRIPTION .....	6
2.5.1 FRONT PANEL .....	6
2.5.2 BACK PANEL.....	6
3. INSTALLING THE CONVERTER.....	7
4. WDM SINGLE FIBER MODEL .....	9
5. LINK FAULT PASSTHROUGH .....	10
6. LED DESCRIPTION.....	12
7. DIP SWITCH AND RESET BUTTON.....	13
8. CABLE CONNECTION PARAMETER.....	14
A.1 ELECTRONIC EMISSION NOTICES .....	15
A.2 FCC CLASS A STATEMENT .....	15
A.3 NOM STATEMENT.....	16
B.1 DISCLAIMER.....	17
B.2 TRADEMARKS USED IN THIS MANUAL.....	17



## **SAFETY INFORMATION**

### **SAFETY INFORMATION**

**CAUTION:** Circuit devices are sensitive to static electricity, which can damage their delicate electronics. Dry weather conditions or walking across a carpeted floor may cause you to acquire a static electrical charge.

To protect your device, always:

- ◆ Touch the metal chassis of your computer to ground the static electrical charge before you pick up the circuit device.
- ◆ Pick up the device by holding it on the left and right edges only.



# CHAPTER 1: SPECIFICATIONS

## 1. SPECIFICATIONS

**TABLE 1-1. SPECIFICATIONS**

SPECIFICATION	DESCRIPTION
<b>Compliance</b>	
Standards	IEEE802.3u 10/100BASE-TX, 100BASE-FX IEEE802.3z/ab 1000BASE-T IEEE802.3af/at Power over Ethernet
Certifications	FCC Part 15 Class A; CE Mark
<b>Data Transfer Rate</b>	
Speed	1000 Mbps, 100 Mbps, 10 Mbps
Forwarding Rate	14,880 pps, 148,800 pps, 1,488,000 pps
<b>Flow Control</b>	
Full duplex	IEEE802.3x compliant for full duplex
Half-duplex	Backpressure flow control for half-duplex
<b>Cable</b>	
UTP	CAT5 cable (up to 328 ft. [100 m])
Fiber	50/125, 62.5/125 or 100/140 $\mu$ m multimode; 8.3/125, 8.7/125, 9/125 or 10/125 $\mu$ m singlemode
<b>Indicators</b>	
LEDs	POWER, PoE, TP LNK/ACT, SPD, FX LNK/ACT, ALRM, 15.4 W, 30 W
<b>Power</b>	
PSE	Supports "Endpoint" via TP pin 1, 2, 3, 6
PoE Power Capacity	802.af: 15.4 W; 802.at: 30 W
Power Requirement, AC Line	100 to 240 VAC, 47 to 63 Hz
Power Consumption	Max. up to 65 W
<b>Environmental</b>	
Operating Temperature	32 to 122° F (0 to 50° C)
Humidity	5% to 95%
<b>Mechanical</b>	
Connectors	LPS500A-MM-LC-R3: (1) RJ-45 PoE, (1) pair of multimode LC; LPS500A-MM-SC-R3: (1) RJ-45 PoE, (1) pair of multimode SC; LPS500A-SM-10K-LC-R3: (1) RJ-45 PoE, (1) pair of singlemode LC
Dimensions	1.6" H x 6.2" W x 5.2" D (4.0 x 15.8 x 13.3 cm)

NOTE: For connecting this device to a router, bridge, or switch, refer to the corresponding device's user manual.



## CHAPTER 2: OVERVIEW

### 2. OVERVIEW

#### 2.1 INTRODUCTION

The unmanaged PoE PSE Media Converter is a next generation Ethernet media converter offering one gigabit per second performance. It is used in Ethernet copper to fiber media conversion applications over long distances.

The media converter delivers one (10M/100M/1G) RJ-45 with one PoE port (supports 802.3af/at up to 15.4 W/30 W) and one GbE SC or LC port. The converter provides high hardware performance and environment flexibility for Ethernet applications.

#### 2.2 AVAILABLE MODELS

Three models are available:

- ◆ LPS500A-MM-LC-R3: TP to Multimode Fiber Media Converter with RJ-45 and LC connectors
- ◆ LPS500A-MM-SC-R3: TP to Multimode Fiber Media Converter with RJ-45 and SC connectors
- ◆ LPS500A-SM-10K-LC-R3: TP to Singlemode Fiber Media Converter with RJ-45 and SC connectors

#### 2.3 FEATURES

- ◆ RJ-45 link supports IEEE 802.3ab 1000BASE-T Gbps Ethernet over twisted-pair cable
- ◆ Fiber link supports IEEE 802.3z 1000BASE-X Gbps Ethernet over fiberoptic cable
- ◆ Provides IEEE 802.4at maximum 30 W Power over Ethernet (PoE)
- ◆ DIP switch sets PoE, LFP, and normal/cut-through configurations
- ◆ Power over Ethernet (PoE): The PoE converter provides PoE power and supports various PoE PD device types (IP-phone, IP-camera, WiFi-AP) for end users to eliminate an extra power cable to these devices
- ◆ Link Fault Passthrough (LFP): When this is enabled, the UTP receiver is passed to the fiber transmitter to make the media converter appear transparent to the end devices that are connected. It uses LFP to indicate when far-end fault issues occur. If a fault occurs, the end devices indicate a failure for troubleshooting.

#### 2.4 WHAT'S INCLUDED

Your package should contains the following items. If anything is missing or damaged, contact Black Box Technical Support at 877-877-2269 or [info@blackbox.com](mailto:info@blackbox.com)

- ◆ 10/100/1000BASE-T to 1000BASE-X PoE PSE GbE Media Converter
- ◆ AC Power Cord

## CHAPTER 2: OVERVIEW

### 2.5 HARDWARE DESCRIPTION

Figures 2-1 and 2-2 show the front and back panel of the converter. Table 2-1 describes the components.

#### 2.5.1 FRONT PANEL

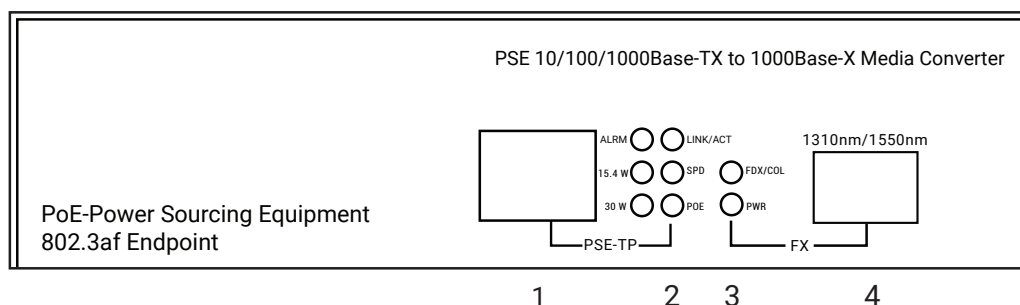

FIGURE 2-1. POE PSE MEDIA CONVERTER FRONT PANEL

#### 2.5.2 BACK PANEL

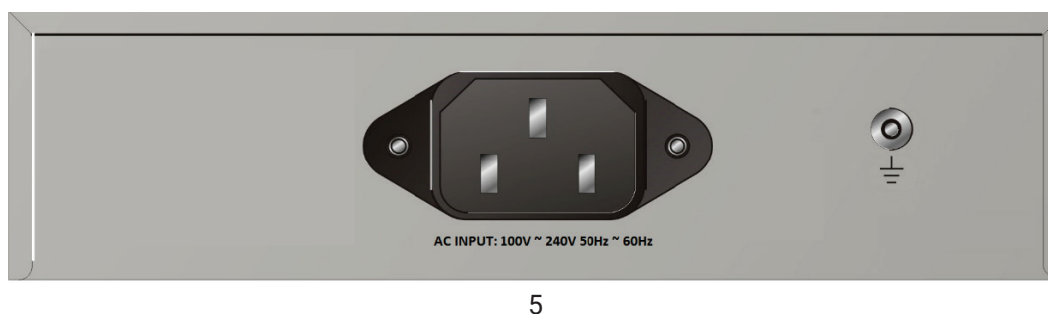

FIGURE 2-2. POE PSE MEDIA CONVERTER BACK PANEL

**TABLE 2-1. CONVERTER COMPONENTS**

NUMBER IN FIGURE 2-1 OR 2-2	SIGNAL	DESCRIPTION
1	(1) RJ-45 PoE connector	Links to Powered Device (PD)
2	(6) TP LEDs: PoE, TP LNK/ACT, SPD, ALRM, 15.4 W, 30 W	Indicates twisted-pair port status
3	(2) FX LEDs: Power, FX LNK/ACT	Indicates fiber port status
4	LPS500A-MM-LC-R3 : (1) multimode LC connector; LPS500A-MM-SC-R3: (1) multimode SC connector; LPS500A-SM-10K-LC-R3: (1) singlemode LC connector	Links to Gigabit fiber network
5	(1) 3-prong power connector	Links to 100 to 240 VAC, 47 to 63 Hz power

# CHAPTER 3: INSTALLING THE CONVERTER

## 3. INSTALLING THE CONVERTER

### PSE TP-Fiber Converter with Powered Device (PD)

1. Connect the PSE media converter to an AC power source.
2. Install the UTP media cable to the IEEE 802.3af PD converter.

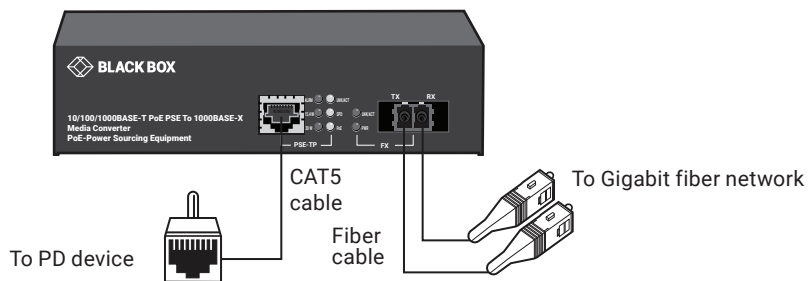

FIGURE 3-1. MEDIA CONVERTER CONNECTIONS

NOTE: It can work as a pure converter that connects to the non-PoE converter.

3. Install the media cable for network connection.

**WARNING:**

- Verify that the AC input conforms to your country AC power requirement and then insert the power plug.
- Ensure that the power of PSE device is turned on
- Install the media cable for network connection

**TABLE 3-1. CONNECTOR FUNCTIONS**

CONNECTOR	FUNCTION
TP Port	10/100BASE-TX: Auto-Negotiation Auto-MDIX flow control for Full-Duplex backpressure for Half-Duplex
	1000BASE-TX: Auto-Negotiation mode Auto-MDIX only for Auto-Negotiation flow control for Full-Duplex only
Fiber Port	1000BASE-SX/LX (SC/LC) with flow control NOTE: Link partner must be 1000FDX with flow control

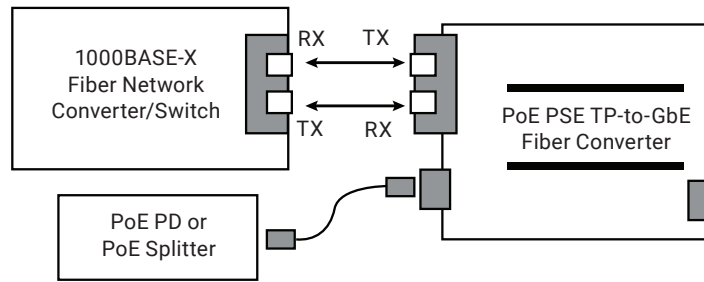

FIGURE 3-2. PSE TO PD OR POE SPLITTER

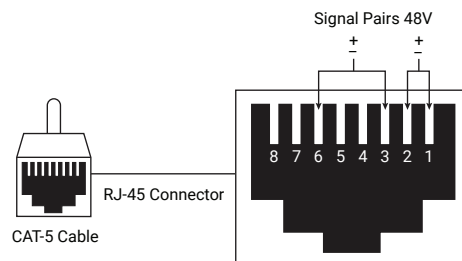

FIGURE 3-3. ENDPOINT PSE RJ-45 MALE CONNECTOR

NOTE: IEEE802.3af assigns pairs on the RJ-45 connector and Cat.5 cable of Endpoint PSE.

Endpoint : -48V via TP pin 1, 2, 3, 6



# CHAPTER 4: WDM SINGLE-FIBER MODEL

## 4. WDM SINGLE FIBER MODEL

The TP-Fiber converter is specially designed with an optic Wavelength Division Multiplexing (WDM) model that can transport a bidirectional full duplex signal over a single fiber simultaneously.

**TABLE 4-1. SINGLE-FIBER TX/RX WAVELENGTH**

SINGLE-FIBER MODEL	TX/RX WAVELENGTH
1310-nm singlemode 10 km	TX (Transmit) 1310 nm
	RX (Receive) 1550 nm
1550-nm singlemode 10 km	TX (Transmit) 1550 nm
	RX (Receive) 1310 nm

NOTE: The 1310 nm and 1550 nm models must be installed in pairs, i.e., install 1310 nm model at one end and 1550 nm model at the other one.

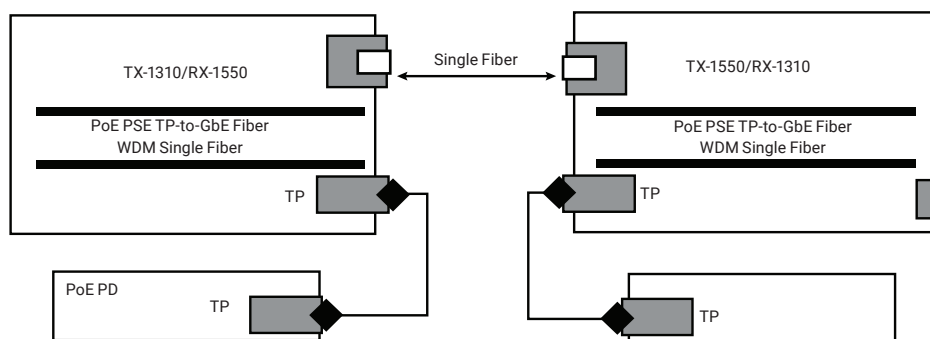

FIGURE 4-1. POWER FROM PSE TO PD

## CHAPTER 5: LINK FAULT PASSTHROUGH

### 5. LINK FAULT PASSTHROUGH

The LFP (link fault passthrough) in a TX/FX converter application is controlled by the software and instantly takes effect. Link status on one port is propagated to the other port to notice the remote nodes. If the TP port is unplugged, this converter stops transmission on the fiber port. This causes the remote fiber node link to fail. An LED shows the link failure on both TP and fiber ports. If the fiber link fails, this converter restarts auto-negotiation on the TP port but always stays in the link failure state. This causes the remote TP node link to fail. An LED also shows the link failure on both TP and fiber ports. Refer to Figure 5-1 shown below for the normal status when the link succeeds.

Also refer to Figure 5-2 and Figure 5-3 for the error status when TP Cable A, Fiber Cable B, or Fiber Cable C fails to connect.

NOTE: Link fault pass through (LFP) function only takes effect as S1-Bit2 (see Figure 5-4) is enabled. Disabled S1-Bit2 will turn this media converter into a general one.

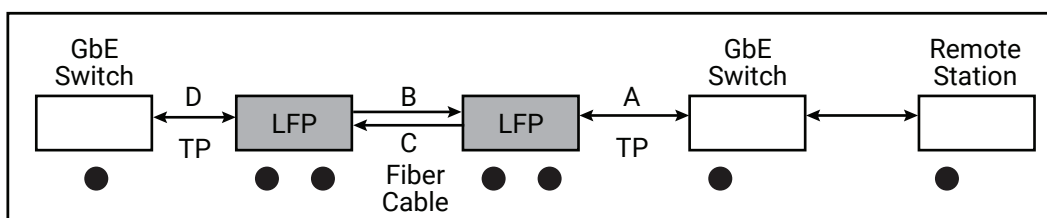

FIGURE 5-1. NORMAL STATUS VIA LFP CONVERTER

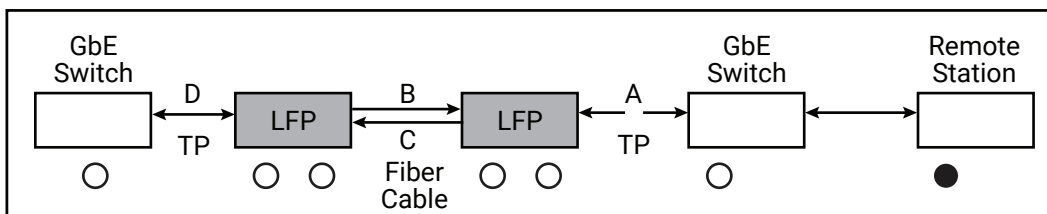

FIGURE 5-2. THE STATUS AS TP CABLE A OR D IS BROKEN

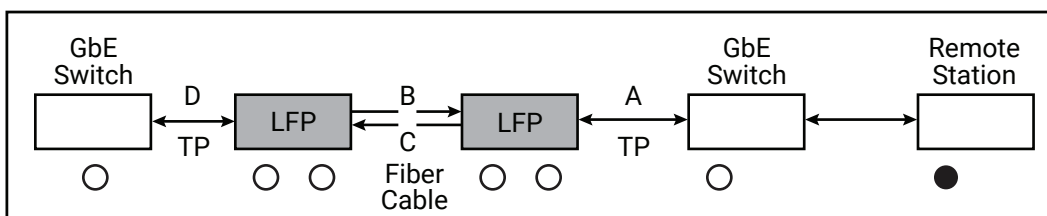

FIGURE 5-3. THE STATUS AS FIBER CABLE B OR C IS BROKEN

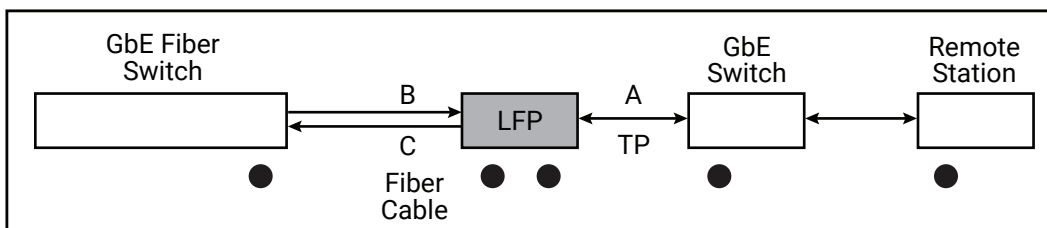

FIGURE 5-4. NORMAL STATUS VIA LFP CONVERTER

# CHAPTER 5: LINK FAULT PASSTHROUGH

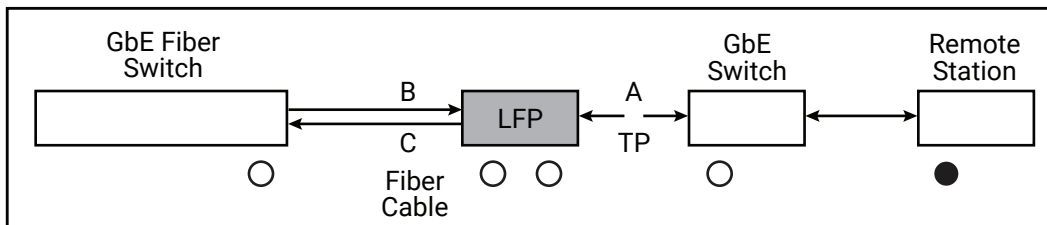

FIGURE 5-5. THE STATUS AS TP CABLE A IS BROKEN

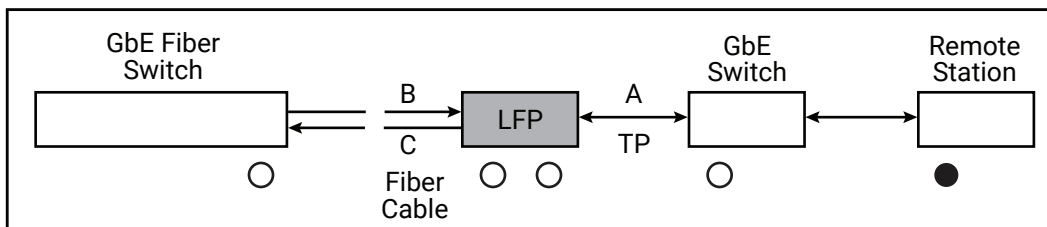

FIGURE 5-6. THE STATUS AS FIBER CABLE B OR C IS BROKEN

**NOTE:**

Black circle: Indicates LNK/ACT LED Lit

Open circle (black outline): Indicates LNK/ACT LED Off

NOTE: The LFP (Link Fault Passthrough) function can work with different link partners (for example: Fiber port on Switch). It does not need both converters with the same model in pairs.

## CHAPTER 6: LED DESCRIPTION

### 6. LED DESCRIPTION

**TABLE 6-1. LED INDICATORS**

LED	COLOR	FUNCTION
FX LNK/ACT	Green	Lit when fiber connection is good Blinks when packet is forwarding on fiber port
TP LNK/ACT	Green	Lit when TP connection is good Blinks when packet is forwarding on TP port
TP SPD	Green/Yellow	Green lit when TP speed is 1000 Mbps Yellow lit when TP speed is 100 Mbps Off when TP speed is 10 Mbps
PWR	Green	Lit when power is coming up Off when power was turned off
PoE	Green/Red	Lit green when PoE power is active Lit red when PoE feeling was disrupted (In case of over-temp or over-current) Off when PoE power was turned off
ALRM	Red	Lit red for Alarm
15.4 W	Green	Lit when PD Class Type is Class 0–3
30 W	Green	Lit when PD Class Type is Class 4



## CHAPTER 7: DIP SWITCH AND RESET BUTTON

### 7. DIP SWITCH AND RESET BUTTON

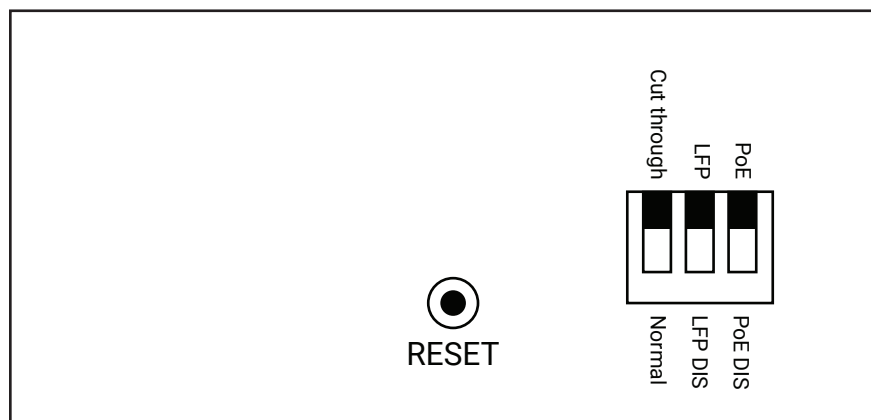

FIGURE 7-1. RESET BUTTON AND S1–BIT 1, 2, 3 CONFIGURATION AND SETTING

Reset: Once S1-1, S1-2 is changed, press this button to activate the setting

S1-1 Bridge mode : Cut through (default) or Normal

S1-2 LFP : LFP enabled(default) or disabled

S1-3 PoE ON/OFF : Enable(default) or disable

#### NOTES:

1. S1-1 : Cut through mode support jumbo frame size max. up to 9216 bytes. Normal mode max. frame size up to 2048 .bytes
2. S1-3 : Must be set to PoE ON while power supplies to PD.

## CHAPTER 8: CABLE CONNECTION PARAMETER

### 8. CABLE CONNECTION PARAMETER

1000BASE-SX/LX networks only support full-duplex mode. The Switch based Media Converter breaks up TP and Fiber segments' collision domain to extend the cabling distance.

- ♦ UTP Cables: CAT5, or above CAT5e class UTP cables
- ♦ UTP Cable Limitations: Max. Length up to 328 feet (100 m)
- ♦ Fiber Cables:
  - 1000BASE-SX: 50/125, 62.5/125, or 100/140µm multimode
  - 1000BASE-LX: 8.3/125, 8.7/125, 9/125 or 10/125µm singlemode

**TABLE 8-1. FIBER CABLE LIMITATIONS**

LED	MULTIMODE FIBER		SINGLEMODE FIBER	
	BANDWIDTH MHZ-KM	DISTANCE	BANDWIDTH MHZ-KM	DISTANCE
1000BASE-SX (850 NM)	260	220 m	400	500 m
	200	275 m	500	550 m
	Single-Mode Fiber 9/125µm: 2Km Single-Mode Transceiver 1310nm: 10/30Km Single-Mode Transceiver 1550nm: 50Km			

**TABLE 8-2. SINGLE-FIBER TX/RX WAVELENGTH**

SINGLE-FIBER MODEL	TX/RX WAVELENGTH
1310-nm singlemode 10 km	TX (Transmit) 1310 nm
	RX (Receive) 1550 nm
1550-nm singlemode 10 km	TX (Transmit) 1550 nm
	RX (Receive) 1310 nm

NOTE: The 1310 nm and 1550 nm models must be installed in pairs, i.e., install 1310 nm model at one end and 1550 nm model at the other end.



## APPENDIX A: REGULATORY INFORMATION

### A.1 ELECTRONIC EMISSION NOTICES

This equipment has been tested and found to comply with the FCC Part 15, Subpart B, Class A and protection requirements of European Emission Standard as follows:

EMI Comply with FCC Part 15 Class A & CE Mark Approval

LVD EN 62368-1

Safety UL and others by request

### A.2 FCC CLASS A STATEMENT

This equipment generates, uses, and can radiate radio-frequency energy, and if not installed and used properly, that is, in strict accordance with the manufacturer's instructions, may cause interference to radio communication. It has been tested and found to comply with the limits for a Class A computing device in accordance with the specifications in Subpart B of Part 15 of FCC rules, which are designed to provide reasonable protection against such interference when the equipment is operated in a commercial environment. Operation of this equipment in a residential area is likely to cause interference, in which case the user at his own expense will be required to take whatever measures may be necessary to correct the interference.

Changes or modifications not expressly approved by the party responsible for compliance could void the user's authority to operate the equipment.

This digital apparatus does not exceed the Class A limits for radio noise emission from digital apparatus set out in the Radio Interference Regulation of Industry Canada.

Le présent appareil numérique n'émet pas de bruits radioélectriques dépassant les limites applicables aux appareils numériques de classe A prescrites dans le Règlement sur le brouillage radioélectrique publié par Industrie Canada.

## APPENDIX A: REGULATORY INFORMATION

### A.3 NOM STATEMENT

1. Todas las instrucciones de seguridad y operación deberán ser leídas antes de que el aparato eléctrico sea operado.
2. Las instrucciones de seguridad y operación deberán ser guardadas para referencia futura.
3. Todas las advertencias en el aparato eléctrico y en sus instrucciones de operación deben ser respetadas.
4. Todas las instrucciones de operación y uso deben ser seguidas.
5. El aparato eléctrico no deberá ser usado cerca del agua—por ejemplo, cerca de la tina de baño, lavabo, sótano mojado o cerca de una alberca, etc.
6. El aparato eléctrico debe ser usado únicamente con carritos o pedestales que sean recomendados por el fabricante.
7. El aparato eléctrico debe ser montado a la pared o al techo sólo como sea recomendado por el fabricante.
8. Servicio—El usuario no debe intentar dar servicio al equipo eléctrico más allá a lo descrito en las instrucciones de operación. Todo otro servicio deberá ser referido a personal de servicio calificado.
9. El aparato eléctrico debe ser situado de tal manera que su posición no interfiera su uso. La colocación del aparato eléctrico sobre una cama, sofá, alfombra o superficie similar puede bloquea la ventilación, no se debe colocar en libreros o gabinetes que impidan el flujo de aire por los orificios de ventilación.
10. El equipo eléctrico deber ser situado fuera del alcance de fuentes de calor como radiadores, registros de calor, estufas u otros aparatos (incluyendo amplificadores) que producen calor.
11. El aparato eléctrico deberá ser conectado a una fuente de poder sólo del tipo descrito en el instructivo de operación, o como se indique en el aparato.
12. Precaución debe ser tomada de tal manera que la tierra física y la polarización del equipo no sea eliminada.
13. Los cables de la fuente de poder deben ser guiados de tal manera que no sean pisados ni pellizcados por objetos colocados sobre o contra ellos, poniendo particular atención a los contactos y receptáculos donde salen del aparato.
14. El equipo eléctrico debe ser limpiado únicamente de acuerdo a las recomendaciones del fabricante.
15. En caso de existir, una antena externa deberá ser localizada lejos de las líneas de energía.
16. El cable de corriente deberá ser desconectado del cuando el equipo no sea usado por un largo periodo de tiempo.
17. Cuidado debe ser tomado de tal manera que objetos líquidos no sean derramados sobre la cubierta u orificios de ventilación.
18. Servicio por personal calificado deberá ser provisto cuando:
  - A: El cable de poder o el contacto ha sido dañado; u
  - B: Objetos han caído o líquido ha sido derramado dentro del aparato; o
  - C: El aparato ha sido expuesto a la lluvia; o
  - D: El aparato parece no operar normalmente o muestra un cambio en su desempeño; o
  - E: El aparato ha sido tirado o su cubierta ha sido dañada.





## APPENDIX B: DISCLAIMER/TRADEMARKS

### B.1 DISCLAIMER

Black Box Corporation shall not be liable for damages of any kind, including, but not limited to, punitive, consequential or cost of cover damages, resulting from any errors in the product information or specifications set forth in this document and Black Box Corporation may revise this document at any time without notice.

### B.2 TRADEMARKS USED IN THIS MANUAL

Black Box and the Black Box logo type and mark are registered trademarks of Black Box Corporation.

Any other trademarks mentioned in this manual are acknowledged to be the property of the trademark owners.







**NEED HELP?  
LEAVE THE TECH TO US**

---

**LIVE 24/7  
TECHNICAL  
SUPPORT**

---

**1.877.877.2269**

