

USER MANUAL

KVSC-16

TOUCHSCREEN CONTROLLER, KVM

24/7 TECHNICAL SUPPORT AT 877.877.2269 OR VISIT BLACKBOX.COM



BLACK BOX

TABLE OF CONTENTS

1. SPECIFICATIONS	3
2. OVERVIEW	4
2.1 INTRODUCTION	4
2.2 NO MORE CONFUSION	4
2.3 KEYBOARD AND MOUSE ACCESS BUILT-IN	4
3. INSTALLATION GUIDE	5
4. SETTINGS CONFIGURATION	6
4.1 CHANGING COMPUTER COLORS	6
4.2 ACCESSING ADMIN SETTINGS FROM AN EXTERNAL COMPUTER	7
4.3 SWITCHING CHANNELS	17
4.4 CAC	17
APPENDIX A. REGULATORY INFORMATION	18
A.1 FCC CLASS A STATEMENT	18
A.2 NOM STATEMENT	19
APPENDIX B. DISCLAIMER/TRADEMARKS	20
B.1 DISCLAIMER	20
B.2 TRADEMARKS USED IN THIS MANUAL	20



CHAPTER 1: SPECIFICATIONS

1. SPECIFICATIONS

TOUCHSCREEN CONTROLLER, KVM (KVSC-16) SPECIFICATIONS

CONNECTORS

INPUT INTERFACE	(1) USB Type B (female) for connecting NIAP4 Switch / Compatible active USB Extender (1) RJ-11 for Serial configuration / external switching (1) USB Type B Mini for Serial configuration if the Virtual COM port is enabled at bootup
OUTPUT INTERFACE	(2) USB Type A (female) for connecting the HID Keyboard and HID mouse to control target computers

DISPLAY

LCD TYPE	IPS, TFT LCD
VIEWING ANGLE	Wide viewing angle,85°/85°/85°/85°(L/R/U/D)
RESOLUTION	320×480 pixels (0°/90°/180°/270°)
COLOR	24-bit 8R8G8B
ACTIVE AREA (A.A.)	49.0mm (W)×73.4mm (H)
VIEW AREA (V.A.)	49.7mm (W)×74.1mm (H)
BACKLIGHT MODE	LED
BACKLIGHT SERVICE LIFE	>20000 hours

TOUCH

TYPE	RTP (Resistive touch panel)
STRUCTURE	ITO film + ITO glass
TOUCH MODE	Single point touch
LIGHT TRANSMITTANCE	Over 80%
LIFE	Over 1,000,000 touches

CONTROL

FRONT PANEL	Touch Screen
--------------------	--------------

OTHER

POWER SUPPLY	5 VDC, 3 A
WEIGHT	0.42 lbs
DIMENSIONS	5.37" W, 3.93" D, 2.25" H
OPERATING TEMPERATURE	+32 to +104°F (0 to +40°C)
STORAGE TEMPERATURE	-4 to +140°F (-20 to +60°C)
HUMIDITY	Up to 80% (non-condensing)

CHAPTER 2: OVERVIEW

2.1 INTRODUCTION

The KVSC-16 is a dynamic touchscreen controller that is used to control Black Box Secure KVM switches and any other commercial KVM switch from a single USB cable with optional extension.

Black Box's Secure KVM Switches are designed for use in secure defense and intelligence applications where sensitive data must be protected. The Secure KVM Switches are equipped with the highest security features that meet today's Information Assurance safe control standards. The switch itself is limited as you can currently only switch the channel by pressing the physical buttons on the front panel of the KVM switch. This makes it very difficult to store all the computers in a secure location and still be able to control the switch in an efficient manner.

The KVSC-16 solves this problem. The Touchscreen Controller uses an encrypted protocol to communicate with any Black Box KVM Switch to easily control the Switch from up to 100 feet (30 meters) away.

2.2 NO MORE CONFUSION

The current method of switching channels on the Secure KVM switch can be very confusing. For a 16-port switch, the operator would have to remember exactly which computers are secure and which are not just based on a number. The KVSC-16 makes this simpler by adding clearly visible text and color that allow the operator to clearly identify the correct computer to access and reduce the possibility of accessing the wrong computer. The text and color are customizable to fit a wide range of needs for organization. Users access the configuration menu through RS-232 to any PC, so they can easily customize the KVSC-16 to fit their needs.

2.3 KEYBOARD AND MOUSE ACCESS BUILT-IN

The KVSC-16 offers a game-changing feature in providing ports for a keyboard and mouse directly on the remote in order to be able to control the connected computers on the switch from up to 100 feet (30 meters) away. All of the secure keyboard and mouse emulation when connected directly to the switch is still available when connecting these peripherals to the KVSC-16. All software and hardware security features are still in place when using the KVSC-16 with a keyboard and mouse.



CHAPTER 3: INSTALLATION GUIDE

Follow the steps below to properly connect the KVSC-16 to a Black Box Secure KVM.

1. Ensure that power is turned off or disconnected from the unit and the computers.
2. Use the desired length of USB cable (Type A to Type B) to connect the USB Type B port on the KVSC-16 to the USB Type A port labeled "KM" on the KVM.
3. If using the active USB extender, plug this cable into the Receiver of the USB active extender. Plug the USB extender transmitter into the USB Type A port labeled "KM" on the KVM, then run a CATx cable between the USB active transmitter and receiver.
4. Insert a keyboard and mouse into the USB Type A ports on the KVSC-16.
5. If RS232 / external switching is required, use an RJ-11 to RS-232 serial cable. Connect the RJ-11 end to the KVSC-16 and the other end to the serial controller.
6. Power on the Touchscreen Remote by connecting a power supply to the barrel connector on the back of the KVSC-16.
7. Power on the NIAP4 KVM / KM switch, and then power on all computers.

Figure 1 illustrates how the KVSC-16 fits within a standard computing environment and how to organize the various cable connections.

Note: All hardware must be physically connected prior to powering the system up. Failure to follow this step will result in the NIAP4 triggering its anti-tamper feature and the KVSC-16 won't work correctly.

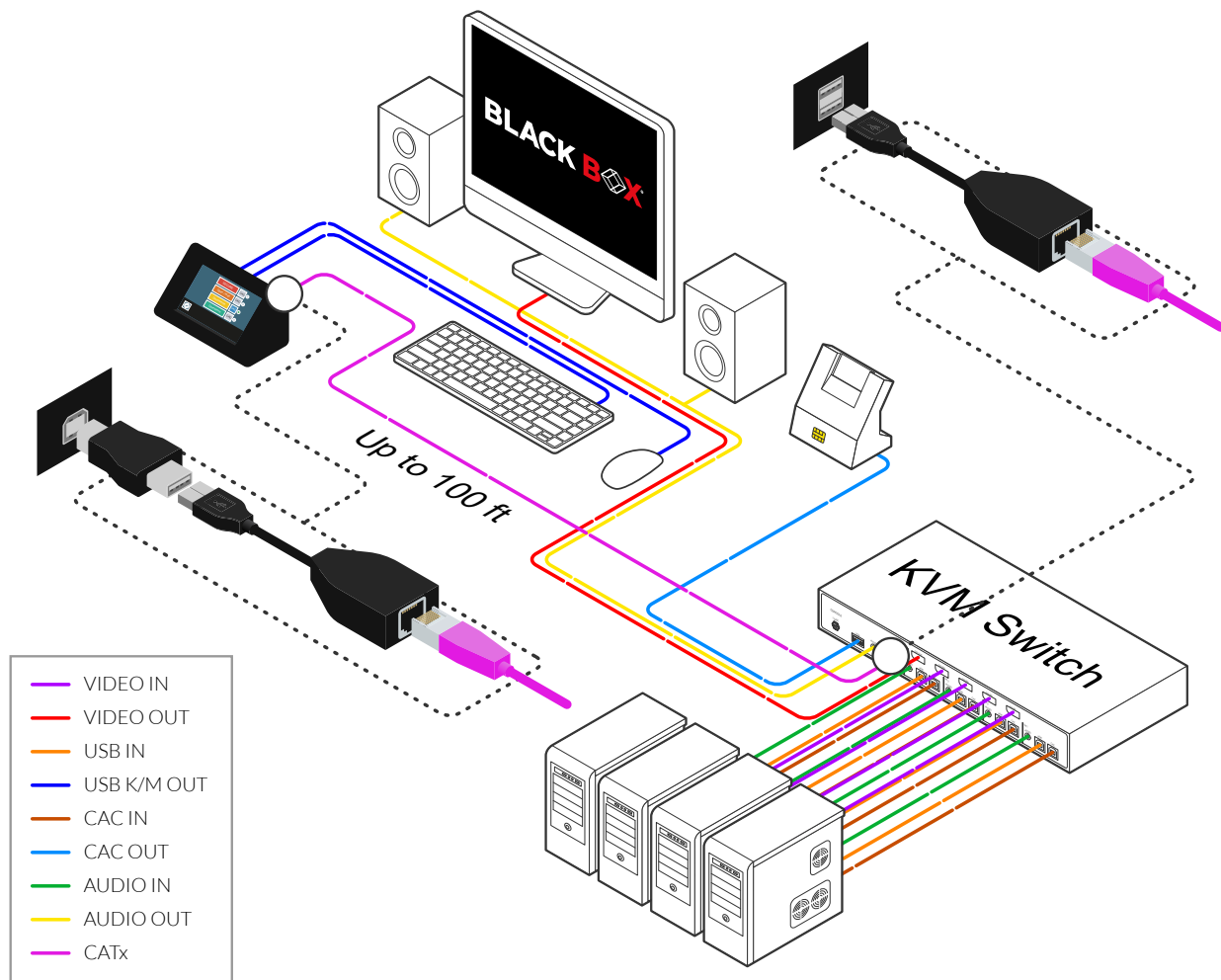

Figure 1. Typical installation

CHAPTER 4: SETTING CONFIGURATION

4.1 CHANGING COMPUTER COLORS

To change the color of a computer on the Touchscreen Remote:

- Select the computer's name on the Touchscreen Remote.
- Click the settings icon as shown in Figure 2.

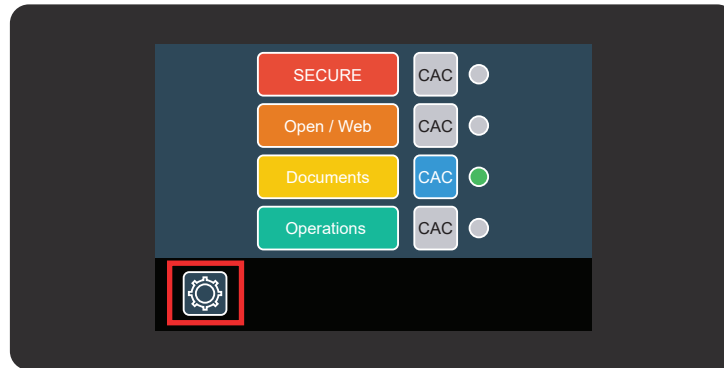

Figure 2. Settings icon

- Click "change color."
- Select the color you wish to use, then press "OK."

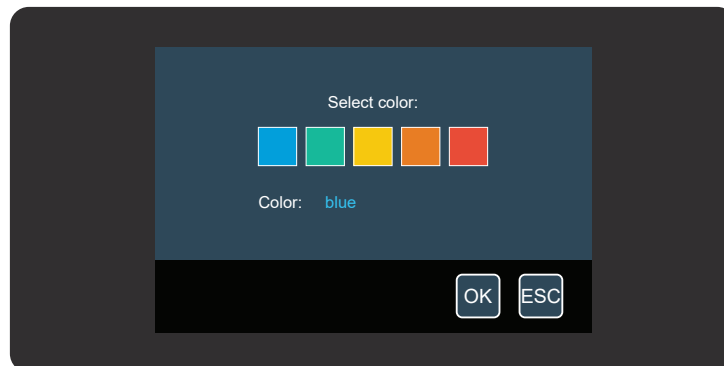

Figure 3. Select color

CHAPTER 4: SETTING CONFIGURATION

4.2 ACCESSING ADMIN SETTINGS FROM AN EXTERNAL COMPUTER

Initial Setup of the Serial Connection

To access the administrator settings, a RS232 / Serial connection can be established with the LCD panel to configure / switch ports using an external serial controller. There are two methods of accessing the administrator settings which are explained below.

Note: The steps below show an example when using a Windows based operating system to configure the panel. Similar steps should be taken on other operating systems, but may not be depicted here.

Using VCOM (Virtual COM)

The KVSC-16 is equipped with an internal USB to RS232 (serial) converter which allows the end user / administrator to configure the settings without having to use any special adapters. This connection can only be used at startup of the LCD panel for configuration only. This serial connection does not support external switching during normal operation if the keyboard/mouse is required since this is a shared / dual-use USB Port. To use this port for configuration, follow these steps below.

Physically connecting to the VCOM Port

1. Connect a USB Type A to B cable between the KVSC-16 and a Laptop / Computer that has a serial program (such as Putty, TeraTerm, etc.).
2. Turn on the KVSC-16 by plugging in the external power adapter into the barrel connector on the rear of the panel.
3. Watch the loading screen on the panel, when it says "Double tap settings for VCOM", tap the Gear icon two times.
4. If successful, the message "Config. By VCOM" will be displayed on the screen.
5. The Laptop / Computer connected to the serial port will enumerate the COM connection automatically and you will see USB popups and USB notifications if sound is enabled.
6. You will have to configure the Virtual COM Port in your Device Manager on the Laptop / Computer now. Use the reference steps below.

CHAPTER 4: SETTING CONFIGURATION

Configuring the VCOM Port

1. On the Laptop / Computer that is running the serial program, navigate to the Start Menu and type "device manager", then when found, select it.

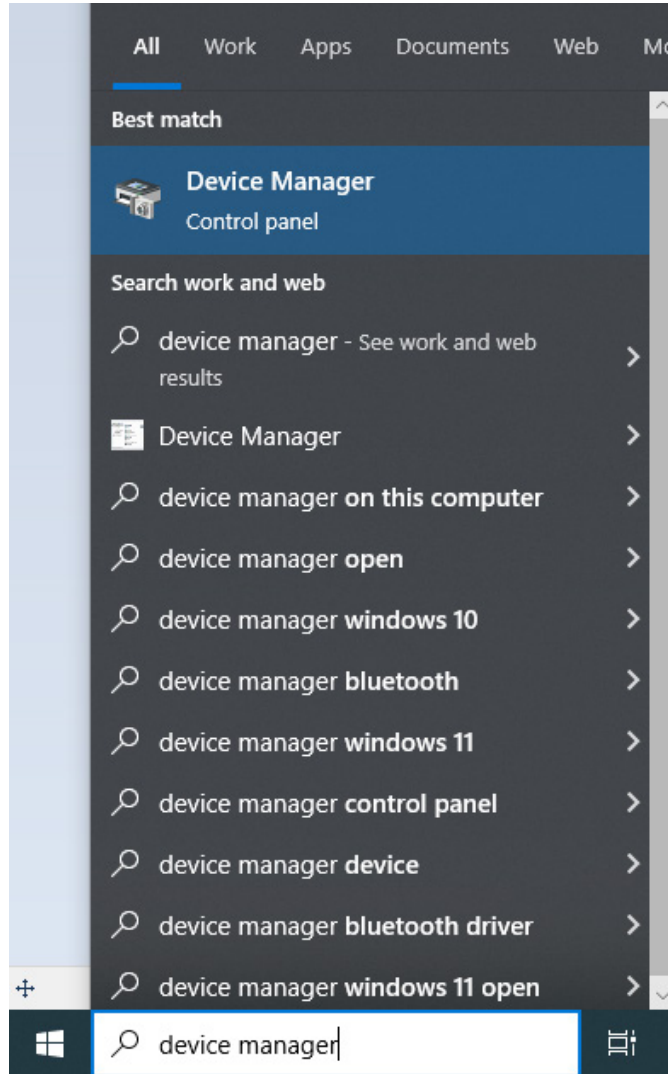

CHAPTER 4: SETTING CONFIGURATION

- In Device Manager, expand the "Ports (COM & LPT)", and right click on the entry that says "USB Serial Device (COM#)" where # is a number between 1-25 usually randomly assigned, then click properties.

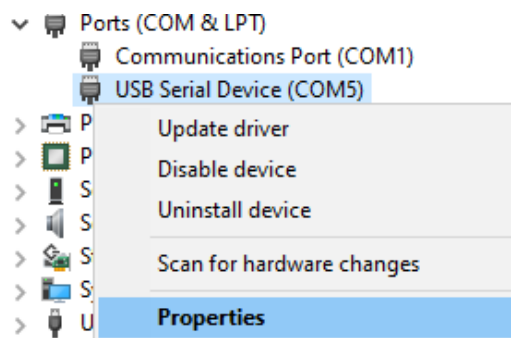
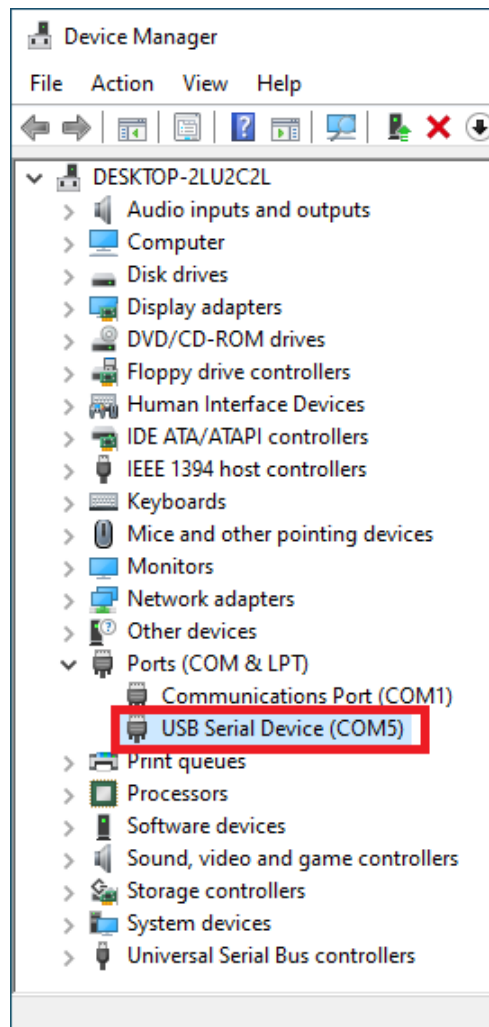

CHAPTER 4: SETTING CONFIGURATION

- When the "USB Serial Device..." window pops up, click on the "Port Settings" tab and configure the port using the following parameters (115200, 8, None, 1, None).

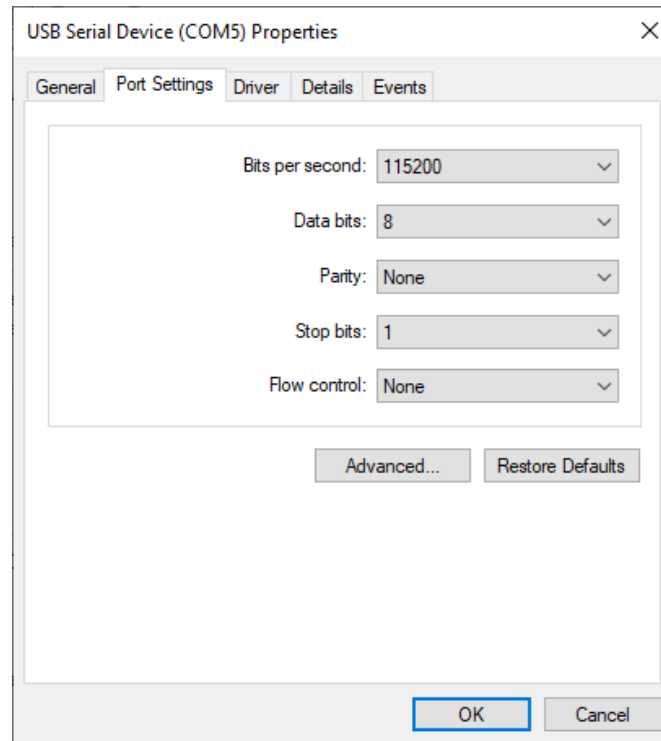

Using the RJ-11 Serial Port

The KVSC-16 is equipped with an RJ-11 interface which can handle serial communication. This port can be used for configuration, and for external switching where a user wants to send a command from a serial controller to switch ports on the KVM. Using this RJ-11 serial port during operation will not affect the user's keyboard and mouse input like the VCOM method. The serial port configuration parameters use (115200, 8, None, 1, None). The RJ-11 port pinning can be found below in the reference diagram.

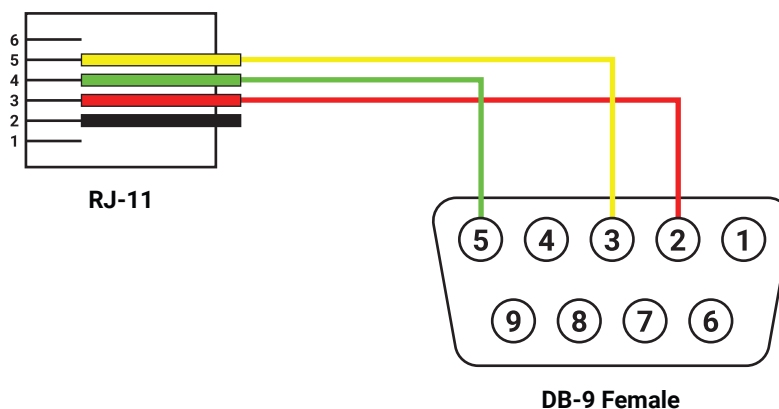

Tip: Sometimes enabling the serial program local echo helps when typing the commands. It will confirm the command is being typed correctly. If local echo is not enabled, you may still type the commands, however you won't see what you are typing.

CHAPTER 4: SETTING CONFIGURATION

Serial Port Usage (Configuration)

The Serial port allows the end user or administrator to configure the panel, and support external serial switching on the KVM (for RJ-11 only). In order to use these features, the commands below can be used.

To get started, open the Serial / RS-232 program to first establish a connection and log in. The steps outlined below are using Putty, however other programs will work too if they support serial / RS-232 communication using the connection parameters outlined above.

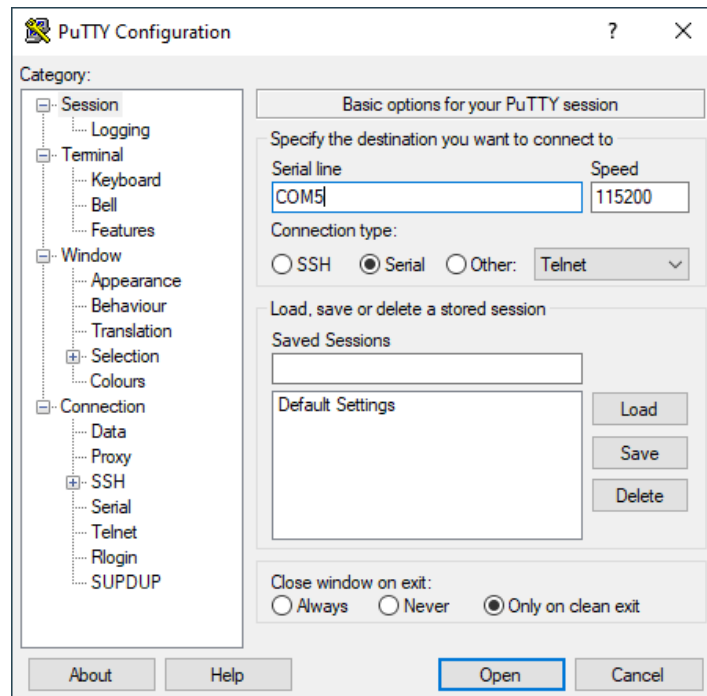

Start the connection, then when at the command prompt, type “//cnfg” in the terminal to continue.

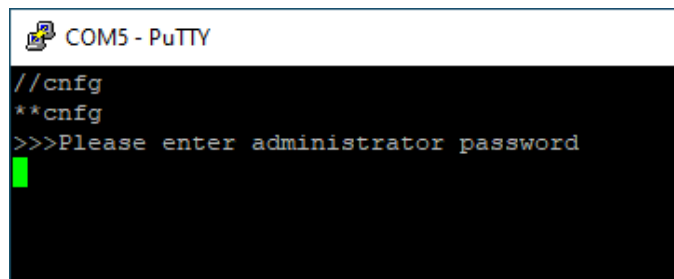

CHAPTER 4: SETTING CONFIGURATION

When prompted to enter the administrator password, type "12345" without the "".

```
COM5 - PuTTY
//cnfg
**cnfg
>>>Please enter administrator password
12345

0. Show Menu
1. View Current Computer Names
2. Update Computer Names
3. Update Administrator Credentials
4. Set CAC mode
5. Logout
6. Restore Factory Defaults
```

MENU ITEM	DESCRIPTION
SHOW MENU	Go back to the main serial menu
VIEW CURRENT COMPUTER NAMES	<p>Prints out the current computer names. This will show all 16 names even if you have a 4- or 8- Port model. If using a smaller port count, only configure the applicable computer names, the others will be discarded.</p> <p>Syntax: Computer names can be a maximum of 11 characters long. Longer names will be truncated to 11 characters.</p> <pre>COM5 - PuTTY 2. Update Computer Names 3. Update Administrator Credentials 4. Set CAC mode 5. Logout 6. Restore Factory Defaults 1 1. COMPUTER 1 2. COMPUTER 2 3. COMPUTER 3 4. COMPUTER 4 5. COMPUTER 5 6. COMPUTER 6 7. COMPUTER 7 8. COMPUTER 8 9. COMPUTER 9 10. COMPUTER 10 11. COMPUTER 11 12. COMPUTER 12 13. COMPUTER 13 14. COMPUTER 14 15. COMPUTER 15 16. COMPUTER 16</pre>

CHAPTER 4: SETTING CONFIGURATION

MENU ITEM	DESCRIPTION
UPDATE COMPUTER NAMES	<p>Edit the computer names with a custom / personalized name. This option allows all 16 computers to be edited, so only edit the computer names that apply to your switch port count. The unused computer names will not be displayed.</p> <p>Syntax: Computer names can be a maximum of 11 characters long. Longer names will be truncated to 11 characters.</p> <pre>COM5 - PuTTY 1 Current name: abcdefghijk >>Please enter new name (max 11 characters, the first character must be a letter or number) Server2016 Computer name changed successfully: Server2016 1. Server2016 2. COMPUTER 2 3. COMPUTER 3 4. COMPUTER 4 5. COMPUTER 5 6. COMPUTER 6 7. COMPUTER 7 8. COMPUTER 8 9. COMPUTER 9 10. COMPUTER 10 11. COMPUTER 11 12. COMPUTER 12 13. COMPUTER 13 14. COMPUTER 14 15. COMPUTER 15 16. COMPUTER 16</pre>
UPDATE ADMINISTRATOR CREDENTIALS	<p>Change the default password from 12345 to something else.</p> <p>Syntax: Password can be up to 32 characters long using lower case and uppercase letters, numbers, and special characters such as (!@#%\$%^&*)</p> <pre>0. Show Menu 1. View Current Computer Names 2. Update Computer Names 3. Update Administrator Credentials 4. Set CAC mode 5. Logout 6. Restore Factory Defaults 3 Please enter current Administrator Password 12345 Please enter new Administrator Password password Please confirm new password password Administrator Password changed successfully</pre>

CHAPTER 4: SETTING CONFIGURATION

MENU ITEM	DESCRIPTION
SET CAC MODE	<p>Enable or Disable CAC switching. If the KVM switch doesn't support CAC, you can disable this feature. If the KVM switch does support CAC, this can optionally be changed.</p> <pre>0. Show Menu 1. View Current Computer Names 2. Update Computer Names 3. Update Administrator Credentials 4. Set CAC mode 5. Logout 6. Restore Factory Defaults 4 Please select CAC mode: 1. CAC Mode 2. Non CAC Mode 2 Non CAC Mode</pre>
LOGOUT	<p>When the session is completed, manually log out using the Logout option. This function will log the admin user out of the serial menu and close all open sessions. In order to log back in after issuing this command, type <code>//cnfg</code> in the terminal to login again.</p> <pre>0. Show Menu 1. View Current Computer Names 2. Update Computer Names 3. Update Administrator Credentials 4. Set CAC mode 5. Logout 6. Restore Factory Defaults 5 Logout</pre>
RESTORE FACTORY DEFAULTS	<p>This function will clear any user configured parameters back to defaults. It will default the computer names, colors, administrator password, and CAC mode. Once the Restore Factory Defaults is issued, pressing Enter or typing option 0 will bring the administrative menu back up.</p> <pre>0. Show Menu 1. View Current Computer Names 2. Update Computer Names 3. Update Administrator Credentials 4. Set CAC mode 5. Logout 6. Restore Factory Defaults 6 Are you sure you want to factory reset the KVM controller? [y/n] y Restoring factory settings //PS 00CAC settings have been set to default. Factory defaults have been restored.</pre>



CHAPTER 4: SETTING CONFIGURATION

While using the serial / RS-232 communications port, Invalid Selection warnings will show periodically if the wrong value was entered, or is out of the range / scope of the variable. This is also a COM port, so even if you do type the correct value in the terminal, you may still get an Invalid Selection warning which is normal. To clear it, try entering the setting again, or keep typing 0 to get back to the main menu. If the terminal refuses to get back to the main menu for whatever reason, the best way to resolve this is by powering down the KVSC-16 and starting from the beginning in order to clear any previous errors.

```
0. Show Menu
1. View Current Computer Names
2. Update Computer Names
3. Update Administrator Credentials
4. Set CAC mode
5. Logout
6. Restore Factory Defaults
4
4
Invalid Selection
0

0. Show Menu
1. View Current Computer Names
2. Update Computer Names
3. Update Administrator Credentials
4. Set CAC mode
5. Logout
6. Restore Factory Defaults
```

CHAPTER 4: SETTING CONFIGURATION

Serial Port Usage (Switching via the RJ-11)

The RJ-11 serial port on the KVSC-16 can be used to accept switching commands from external serial controllers / systems. The available command syntax can be found below.

Note: <CR> is a carriage return which can also be triggered by using the Enter key in most terminals.

Switching KVM Only (not CAC)

COMMAND	DESCRIPTION	COMPATIBILITY
//m 1 <CR>	Switch KVM to port 1	All models
//m 2 <CR>	Switch KVM to port 2	All models
//m 3 <CR>	Switch KVM to port 3	All models
//m 4 <CR>	Switch KVM to port 4	All models
//m 5 <CR>	Switch KVM to port 5	8- / 16-Port models only
//m 6 <CR>	Switch KVM to port 6	8- / 16-Port models only
//m 7 <CR>	Switch KVM to port 7	8- / 16-Port models only
//m 8 <CR>	Switch KVM to port 8	8- / 16-Port models only
//m 9 <CR>	Switch KVM to port 9	16-Port models only
//m 10 <CR>	Switch KVM to port 10	16-Port models only
//m 11 <CR>	Switch KVM to port 11	16-Port models only
//m 12 <CR>	Switch KVM to port 12	16-Port models only
//m 13 <CR>	Switch KVM to port 13	16-Port models only
//m 14 <CR>	Switch KVM to port 14	16-Port models only
//m 15 <CR>	Switch KVM to port 15	16-Port models only
//m 16 <CR>	Switch KVM to port 16	16-Port models only

Switching KVM + CAC

COMMAND	DESCRIPTION	COMPATIBILITY
//c 1 <CR>	Switch KVM + CAC to port 1	All models
//c 2 <CR>	Switch KVM + CAC to port 2	All models
//c 3 <CR>	Switch KVM + CAC to port 3	All models
//c 4 <CR>	Switch KVM + CAC to port 4	All models
//c 5 <CR>	Switch KVM + CAC to port 5	8- / 16-Port models only
//c 6 <CR>	Switch KVM + CAC to port 6	8- / 16-Port models only
//c 7 <CR>	Switch KVM + CAC to port 7	8- / 16-Port models only
//c 8 <CR>	Switch KVM + CAC to port 8	8- / 16-Port models only
//c 9 <CR>	Switch KVM + CAC to port 9	16-Port models only
//c 10 <CR>	Switch KVM + CAC to port 10	16-Port models only
//c 11 <CR>	Switch KVM + CAC to port 11	16-Port models only
//c 12 <CR>	Switch KVM + CAC to port 12	16-Port models only
//c 13 <CR>	Switch KVM + CAC to port 13	16-Port models only
//c 14 <CR>	Switch KVM + CAC to port 14	16-Port models only
//c 15 <CR>	Switch KVM + CAC to port 15	16-Port models only
//c 16 <CR>	Switch KVM + CAC to port 16	16-Port models only



CHAPTER 4: SETTING CONFIGURATION

4.3 SWITCHING CHANNELS

- Switch channels by pressing the name of the computer on the touchscreen. As shown in Figure 7, there are four computers named "Secure," "Open/Web," "Documents," and "Operations".

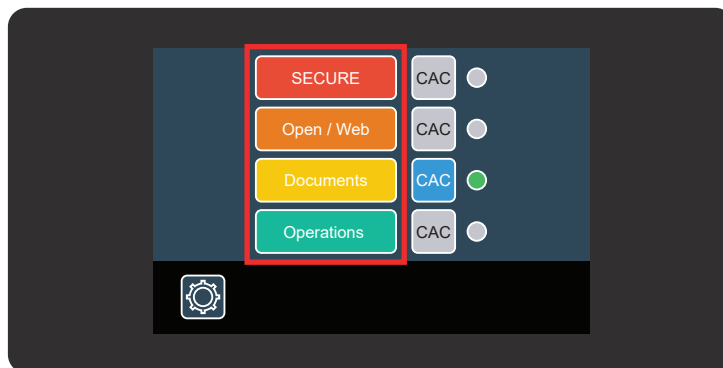

Figure 7. Switching channels

- A green light on the Touchscreen Remote will indicate which computer is selected. In Figure 7, "Documents" is the selected computer.

4.4 CAC

- To enable a CAC device on a specific computer, simply press the CAC button next to the name of the computer on the touchscreen as shown in Figure 8.

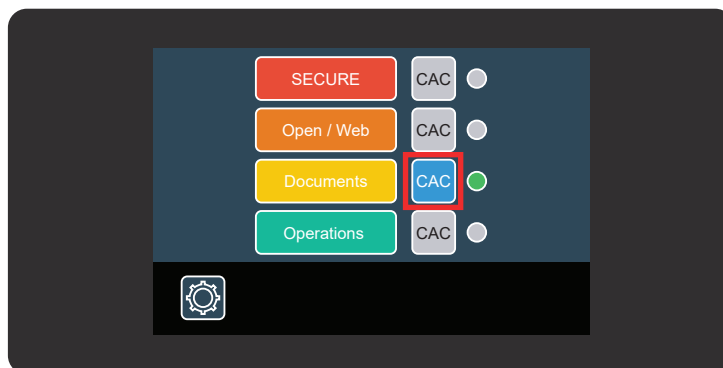

Figure 8. CAC button

- The CAC button will turn blue when CAC is enabled for a specific computer. In the above example, the computer "Documents" has CAC enabled.
- To register and configure CAC devices, refer to the document "Secure KVM Administration and Security Management Tool Guide for KVM and KM" from the following link <https://www.blackbox.com/en-us/NIAP3/documentation>.
- CAC port configuration is detailed in section 6.2.

APPENDIX A: REGULATORY INFORMATION

A.1 FCC CLASS A STATEMENT

This equipment generates, uses, and can radiate radio-frequency energy, and if not installed and used properly, that is, in strict accordance with the manufacturer's instructions, may cause interference to radio communication. It has been tested and found to comply with the limits for a Class A computing device in accordance with the specifications in Subpart B of Part 15 of FCC rules, which are designed to provide reasonable protection against such interference when the equipment is operated in a commercial environment. Operation of this equipment in a residential area is likely to cause interference, in which case the user at his own expense will be required to take whatever measures may be necessary to correct the interference.

Changes or modifications not expressly approved by the party responsible for compliance could void the user's authority to operate the equipment.

This digital apparatus does not exceed the Class A limits for radio noise emission from digital apparatus set out in the Radio Interference Regulation of Industry Canada.

Le présent appareil numérique n'émet pas de bruits radioélectriques dépassant les limites applicables aux appareils numériques de classe A prescrites dans le Règlement sur le brouillage radioélectrique publié par Industrie Canada.



APPENDIX A: REGULATORY INFORMATION

A.2 NOM STATEMENT

1. Todas las instrucciones de seguridad y operación deberán ser leídas antes de que el aparato eléctrico sea operado.
2. Las instrucciones de seguridad y operación deberán ser guardadas para referencia futura.
3. Todas las advertencias en el aparato eléctrico y en sus instrucciones de operación deben ser respetadas.
4. Todas las instrucciones de operación y uso deben ser seguidas.
5. El aparato eléctrico no deberá ser usado cerca del agua—por ejemplo, cerca de la tina de baño, lavabo, sótano mojado o cerca de una alberca, etc.
6. El aparato eléctrico debe ser usado únicamente con carritos o pedestales que sean recomendados por el fabricante.
7. El aparato eléctrico debe ser montado a la pared o al techo sólo como sea recomendado por el fabricante.
8. Servicio—El usuario no debe intentar dar servicio al equipo eléctrico más allá a lo descrito en las instrucciones de operación. Todo otro servicio deberá ser referido a personal de servicio calificado.
9. El aparato eléctrico debe ser situado de tal manera que su posición no interfiera su uso. La colocación del aparato eléctrico sobre una cama, sofá, alfombra o superficie similar puede bloquea la ventilación, no se debe colocar en libreros o gabinetes que impidan el flujo de aire por los orificios de ventilación.
10. El equipo eléctrico deber ser situado fuera del alcance de fuentes de calor como radiadores, registros de calor, estufas u otros aparatos (incluyendo amplificadores) que producen calor.
11. El aparato eléctrico deberá ser conectado a una fuente de poder sólo del tipo descrito en el instructivo de operación, o como se indique en el aparato.
12. Precaución debe ser tomada de tal manera que la tierra física y la polarización del equipo no sea eliminada.
13. Los cables de la fuente de poder deben ser guiados de tal manera que no sean pisados ni pellizcados por objetos colocados sobre o contra ellos, poniendo particular atención a los contactos y receptáculos donde salen del aparato.
14. El equipo eléctrico debe ser limpiado únicamente de acuerdo a las recomendaciones del fabricante.
15. En caso de existir, una antena externa deberá ser localizada lejos de las líneas de energía.
16. El cable de corriente deberá ser desconectado del cuando el equipo no sea usado por un largo periodo de tiempo.
17. Cuidado debe ser tomado de tal manera que objetos líquidos no sean derramados sobre la cubierta u orificios de ventilación.
18. Servicio por personal calificado deberá ser provisto cuando:
 - A. El cable de poder o el contacto ha sido dañado; u
 - B. Objetos han caído o líquido ha sido derramado dentro del aparato; o
 - C. El aparato ha sido expuesto a la lluvia; o
 - D. El aparato parece no operar normalmente o muestra un cambio en su desempeño; o
 - E. El aparato ha sido tirado o su cubierta ha sido dañada.

APPENDIX B: DISCLAIMER/TRADEMARKS

B.1 DISCLAIMER

Black Box Corporation shall not be liable for damages of any kind, including, but not limited to, punitive, consequential or cost of cover damages, resulting from any errors in the product information or specifications set forth in this document and Black Box Corporation may revise this document at any time without notice.

B.2 TRADEMARKS USED IN THIS MANUAL

Black Box and Double Diamond logo are registered trademarks of BB Technologies, Inc.

Any other trademarks mentioned in this manual are acknowledged to be the property of the trademark owners.



**NEED HELP?
LEAVE THE TECH TO US**

**LIVE 24/7
TECHNICAL
SUPPORT**

1.877.877.2269

BLACK BOX



© COPYRIGHT 2024. BLACK BOX CORPORATION. ALL RIGHTS RESERVED.
KVSC-16_USER_REV1.PDF
EN_KVM_Manual_KVSC-16_Rev1_2408